

**CONNECT AND PROTECT**

# Solutions for Electrical Power & Ground Connections

North America

- Insulators
- Busbar Supports
- Connecting Clamps
- Grounding Products
- Cabling Sleeves

  
nvent

**ERIFLEX**



## TABLE OF CONTENTS

Advantages and Markets.....	2
Certificates .....	4
Product Overview .....	5
Copper Busbars.....	6-7
Connecting Clamps and Accessories.....	8-9
nVent ERIFLEX Connecting, Earthing and Neutral Busbars.....	10
Universal Connecting Bars.....	11
CB Connecting Bars.....	12
Grounding Parts .....	13-14
EB-142 and EB-166 Earthing and Neutral Busbar & Accessories .....	15
EB-130 and EB-2X130 Earthing and Neutral Busbar & Accessories .....	16
Earthing and Neutral Busbars with Green/Yellow DIN Rail Clip.....	17
EBC-133 Earthing and Neutral Busbars .....	18
Tinned Aluminum Earthing and Neutral Busbars .....	19
Tinned Aluminum Earthing and Neutral Double Busbars .....	20
Busbar Supports .....	21-31
Spacers and Accessories.....	32
Insulators .....	33-34
Sleeves .....	35-36
Profiles / DIN Rail.....	37
Cross Reference List .....	38-40

# Advantages and Markets

## THE NVENT ADVANTAGE

- A worldwide team of experts in electrical power connections
- Experienced manufacturer and global provider
- Full range of high-quality, reliable, certified products
- Innovative and compatible product designs
- Easy to use – saves time and space
- Maximize power density

## ENERGY

- Electrical Power Generators and Distribution
  - Transformers
  - Generators
- Renewable Energies
  - Windmills
  - Solar
  - Hydropower
- Oil, Gas and Petrochemical
  - Telecom
  - Power Stations



BEFORE



## TRANSPORTATION

- Marine
- Aircraft
- Ground Transportation
- Automotive





## INDUSTRY & BUILDINGS

- Buildings & Shopping Centers
- Air Conditioning
- Elevators, Escalators & Automatic Doors



## PANELBOARD

- Power
- Control & Command Applications:
  - Power Switchboards
  - Distribution Panel
  - UPS
  - Power Factory Correction



## MACHINERY

- Tunneling
- Crunchers
- Printing
- Welding
- Packaging
- Wood Working

AFTER



# Certificates

## TESTS & CERTIFICATES

nVent ERIFLEX components are compliant with several agencies and standards to meet all requirements

### Worldwide Certification

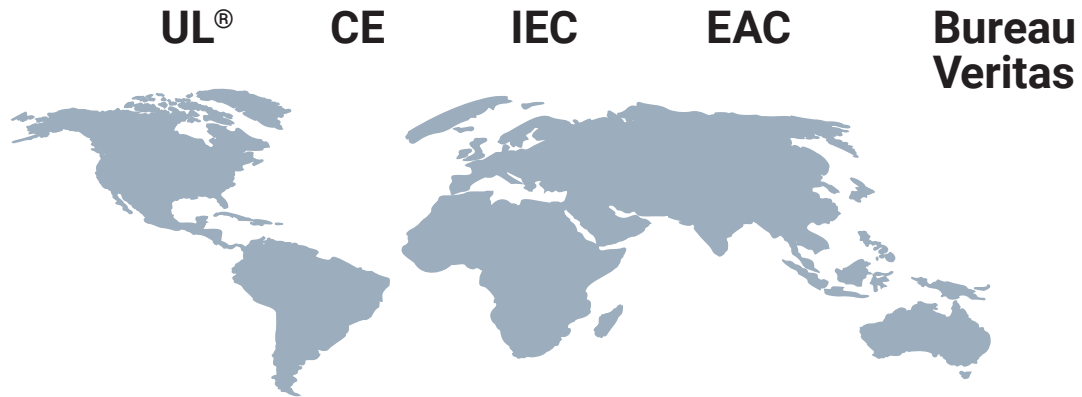

#### Agency/Standard Approvals



International Electrotechnic Commission  
IEC 60439.1 Standard  
IEC 61439.1 Standard



EAC  
Certificate compliance for Russia



Underwriters Laboratories  
UL Recognized, File No. E125470  
UL Recognized, File No. E322841



RoHS Compliant



UL Listed, File No. E220029



Halogen free material



European Conformity



Flame retardant



Bureau VERITAS  
Certificate No. 02859 / DO BV for  
shipboard use



Low smoke

# Product Overview

Product Range	Typical Uses	Typical Market
<p>Copper busbars</p> 	<ul style="list-style-type: none"> <li>• Heavy-duty power connection</li> <li>• Circuit breaker, generator &amp; prefabricated power network conductor</li> <li>• Alternative to large &amp; multiple cables</li> <li>• Earth / ground connection</li> <li>• Power distribution</li> </ul>	<ul style="list-style-type: none"> <li>• Power distribution switchgear</li> <li>• Marine transportation</li> <li>• Machinery manufacturing</li> <li>• Busduct</li> <li>• Power generation</li> </ul>
<p>Connecting clamps</p> 	<ul style="list-style-type: none"> <li>• Heavy-duty power connection</li> <li>• Connection between busbar / flexible busbar / cable</li> <li>• Power distribution</li> <li>• "On site" installation / modification</li> </ul>	<ul style="list-style-type: none"> <li>• Power distribution switchgear</li> <li>• Power generation</li> <li>• Telecom</li> <li>• Machinery manufacturing</li> <li>• Busduct</li> </ul>
<p>Universal connecting bars</p> 	<ul style="list-style-type: none"> <li>• 450A power distribution bar</li> <li>• Unipolar distribution from busbar to cable</li> <li>• "On site" installation / modification</li> </ul>	<ul style="list-style-type: none"> <li>• Power distribution switchgear</li> <li>• Telecom</li> <li>• Machinery manufacturing</li> <li>• Industry &amp; buildings</li> </ul>
<p>Grounding parts</p> 	<ul style="list-style-type: none"> <li>• Power, earthing/grounding and equipotential connections</li> <li>• Numerous connections</li> <li>• Electrical bonding interconnection</li> </ul>	<ul style="list-style-type: none"> <li>• Switchgear &amp; control equipment</li> <li>• Electrical equipment manufacturers</li> <li>• Power generation (Wind, solar)</li> <li>• Data center</li> </ul>
<p>Busbar supports</p> 	<ul style="list-style-type: none"> <li>• Heavy-duty power connection support</li> <li>• Flat, on edge, inclined busbar support</li> <li>• Universal versatile support</li> <li>• Fixed or adjustable busbar support</li> </ul>	<ul style="list-style-type: none"> <li>• Power distribution switchgear</li> <li>• Marine transportation</li> <li>• Machinery manufacturing</li> <li>• Busduct</li> <li>• Power generation</li> </ul>
<p>Spacer &amp; accessories</p> 	<ul style="list-style-type: none"> <li>• Insulated or non-insulated spacer</li> <li>• Accessories for easy distribution block assembly</li> </ul>	<ul style="list-style-type: none"> <li>• Power distribution switchgear</li> <li>• Machinery manufacturing</li> </ul>
<p>Insulators</p> 	<ul style="list-style-type: none"> <li>• Heavy-duty power connection insulator</li> <li>• Flat, on edge, busbar insulator</li> <li>• Universal versatile insulator</li> </ul>	<ul style="list-style-type: none"> <li>• Power distribution switchgear</li> <li>• Marine transportation</li> <li>• Machinery manufacturing</li> </ul>
<p>Sleeves</p> 	<ul style="list-style-type: none"> <li>• Expandable cabling sleeves</li> <li>• Wiring mechanical protection</li> <li>• Wiring temperature protection</li> </ul>	<ul style="list-style-type: none"> <li>• Switchgear &amp; control equipment</li> <li>• Transportation</li> <li>• Machinery manufacturing</li> </ul>
<p>Profiles / DIN Rails</p> 	<ul style="list-style-type: none"> <li>• Symmetric / asymmetric profiles</li> <li>• Perforated or non-perforated profiles</li> <li>• Rapid assembly of all kinds of frameworks</li> </ul>	<ul style="list-style-type: none"> <li>• Switchgear &amp; control equipment</li> <li>• Transportation</li> <li>• Machinery manufacturing</li> </ul>

# Copper Busbars

## THREADED BUSBAR (METRIC)

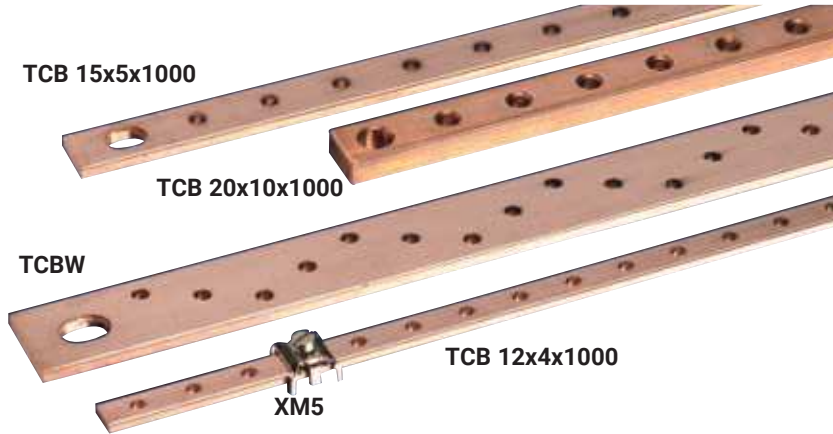

- Electrolytic copper
- Rounded corners
- Thickness: from 2 to 10 mm
- Length: from 1000 to 2000 mm



### TCB

#### ..x 5 x 1000 mm

- Threaded Busbars
- Thickness 5 mm
- Threaded M5, M6
- Length 1000 mm

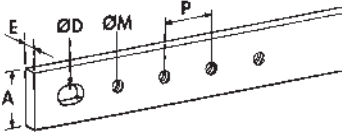

Article No.	Description	A mm	E mm	P mm	ØD mm	ØM	kg
549220	TCB 12 x 5	12	5	18	-	M5	0.50
550210	TCB 15 x 5	15	5	25	8 x 12	M6	0.65
550220	TCB 20 x 5	20	5	25	10 x 14	M6	0.85
550230	TCB 32 x 5	32	5	25	12 x 16	M6	1.35

### TCB

#### ..x 5 x 2000 mm

- Threaded Busbars
- Thickness 5 mm
- Threaded M6
- Length 2000 mm

Article No.	Description	A mm	E mm	P mm	ØD mm	ØM	kg
549000	TCBS 15 x 5	15	5	17.5	8 x 12	M6	1.19
549010	TCB 20 x 5	20	5	25	10 x 14	M6	1.67
549020	TCB 30 x 5	30	5	25	12 x 16	M6	2.50

### TCB

#### ..x 2/4 x 1000 mm

- Threaded Busbars
- Thickness 2, 4 mm
- Threaded M5, M6, M8
- Length 990 mm

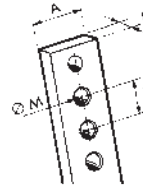

Article No.	Description	A mm	E mm	P mm	ØM	kg
549230	TCB 12 x 2 x 1000	12	2	18	M5	0.300
550200	TCB 12 x 4 x 1000	12	4	18	M5	0.430
549200	TCB 18 x 4 x 1000	18	4	20	M8	0.600
549210	TCB 25 x 4 x 1000	25	4	20	M6	0.800

### TCB

#### 12 x 4 x 2000 mm

- Threaded Busbars 12 x 4
- Thickness 4 mm
- Threaded M5
- Length 1985 mm

Article No.	Description	A mm	E mm	P mm	ØM	kg
550190	TCB 12 x 4 x 2000	12	4	18	M5	0.850

### CONNECTOR XM5

For 12 x 4 Threaded Busbars

Article No.	Description	kg
550250	Connector XM5	0.010

### TCBW

- Threaded Busbars 32 x 5W
- Connections: 40% more
- Thickness 5 mm
- Threaded M6
- Length 2000 mm

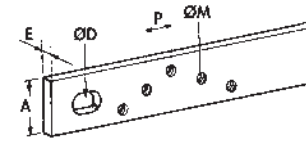

Article No.	Description	A mm	E mm	P mm	ØD mm	ØM	kg
549030	TCBW 32 x 5 x 2000	32	5	17.5	12 x 16	M6	2.65

### TCB

#### ..x 10 x 1000/2000 mm

- Threaded Busbars
- Thickness 10 mm
- Threaded M8
- Length 1000 and 2000 mm

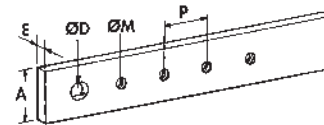

Article No.	Description	A mm	E mm	P mm	ØD mm	ØM	kg
550290	TCB 20 x 10 x 1000	20	10	25	10	M8	1.67
550180	TCB 30 x 10 x 1000	30	10	25	10	M8	2.50

Article No.	Description	A mm	E mm	P mm	ØD mm	ØM	kg
550160	TCB 30 x 10 x 2000	30	10	25	10	M8	5.4

OTHER THREADED BARS ON REQUEST

Products on this page are world wide and are not UL® Recognized

# Copper Busbars

## PUNCHED AND PLAIN BUSBARS (METRIC)

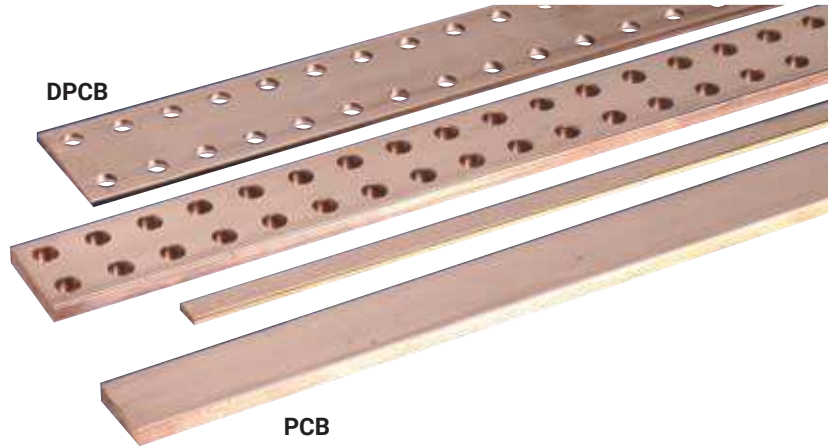

- Design and assembly time saving
- Current: up to 7400 A
- Thickness: from 4 to 10 mm
- Length: from 1000 to 4000 mm



### DPCB

#### Punched Busbars

##### Thickness 5 mm

- Length 1750 mm
- Width 25 to 125 mm

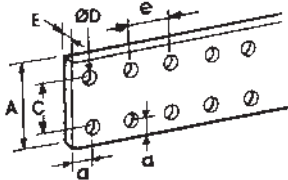

Article No.	Description	A mm	C mm	a mm	e mm	ØD mm	kg
550400	DPCB 25 x 5	25		12.5	25	10.5	2
550410	DPCB 50 x 5	50	25	12.5	25	10.5	2
550420	DPCB 63 x 5	63	38	12.5	25	10.5	2
550430	DPCB 80 x 5	80	55	12.5	25	10.5	2
550440	DPCB 100 x 5	100	75	12.5	25	10.5	2
550450	DPCB 125 x 5	125	100	12.5	25	10.5	2

##### Thickness 10 mm

- Length 1750 mm
- Width 50 to 120 mm

Article No.	Description	A mm	C mm	a mm	e mm	ØD mm	kg
550350	DPCB 50 x 10	50	25	12.5	25	10.5	2
550360	DPCB 60 x 10	60	35	12.5	25	10.5	2
550370	DPCB 80 x 10	80	55	12.5	25	10.5	2
550380	DPCB 100 x 10	100	75	12.5	25	10.5	2
550390	DPCB 120 x 10	120	95	12.5	25	10.5	2

### PCB

#### Plain Busbars

##### Thickness 4 or 5 mm

- Length 1000 and 2000 mm

Article No.	Description	L mm	A mm	E mm	kg
550780	PCB 12 X 4 X 1000	1000	12	4	0.430
550790	PCB 12 X 4 X 2000	2000	12	4	0.850
550770	PCB 12 X 5 X 2000	2000	12	5	1.062

##### Thickness 5 mm

- Length 2000 - 4000 mm
- Width 20 to 125 mm

Article No.	Description	L mm	A mm	E mm	kg
549600	PCB 2 m 25 x 5	2000	25	5	2.20
549610	PCB 2 m 50 x 5	2000	50	5	4.50
549620	PCB 2 m 63 x 5	2000	63	5	5.60
549630	PCB 2 m 80 x 5	2000	80	5	7.10
549640	PCB 2 m 100 x 5	2000	100	5	8.90
550600	PCB 4 m 20 x 5	4000	20	5	3.56
550610	PCB 4 m 25 x 5	4000	25	5	4.45
550620	PCB 4 m 30 x 5	4000	30	5	5.34
550630	PCB 4 m 40 x 5	4000	40	5	7.12
550640	PCB 4 m 50 x 5	4000	50	5	8.90
550650	PCB 4 m 60 x 5	4000	60	5	10.68
550660	PCB 4 m 80 x 5	4000	80	5	14.24
550670	PCB 4 m 100 x 5	4000	100	5	17.80

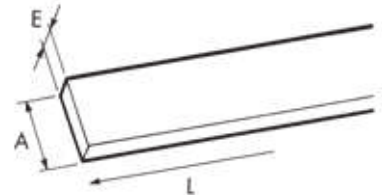

##### Thickness 10 mm

- Length 2000 - 4000 mm
- Width 30 to 200 mm

Article No.	Description	L mm	A mm	E mm	kg
549700	PCB 2 m 30 x 10	2000	30	10	5.30
549710	PCB 2 m 40 x 10	2000	40	10	7.10
549720	PCB 2 m 50 x 10	2000	50	10	8.90
549730	PCB 2 m 60 x 10	2000	60	10	10.70
549740	PCB 2 m 80 x 10	2000	80	10	14.20
549750	PCB 2 m 100 x 10	2000	100	10	17.80
549760	PCB 2 m 120 x 10	2000	120	10	21.40
550970	PCB 4 m 30 x 10	4000	30	10	10.69
550980	PCB 4 m 40 x 10	4000	40	10	14.25
550900	PCB 4 m 50 x 10	4000	50	10	17.80
550910	PCB 4 m 60 x 10	4000	60	10	21.35
550920	PCB 4 m 80 x 10	4000	80	10	28.50
550930	PCB 4 m 100 x 10	4000	100	10	35.60
550940	PCB 4 m 120 x 10	4000	120	10	42.80
550950	PCB 4 m 160 x 10	4000	160	10	57.00

Products on this page are world wide and are not UL® Recognized

# Connecting Clamps and Accessories

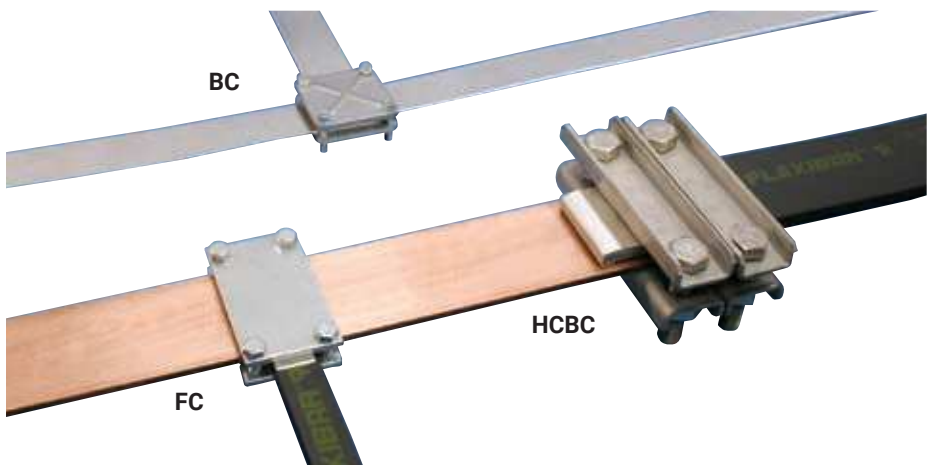

## FC

### nVent ERIFLEX Flexibar Clamp

- Clamping capacity: 0.79 inches
- 2 zinc plated steel plates complete with M8 screws 8.8 class

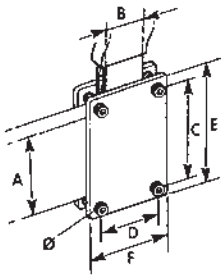

Article No.	Description	A in	B mm	C in	D in	E in	F in	Torque ft/lbs	⊠	lbs
553020	FC 50 x 24	2	20-24	2.32	1.42	2.95	2.05	7.37	3	0.7
553030	FC 50 x 32	2	32	2.32	1.73	2.95	2.36	7.37	3	0.8
553040	FC 50 x 40	2	40	2.32	2.05	2.95	2.68	7.37	3	0.91
553050	FC 80 x 24	3.18	20-24	3.5	1.42	4.13	2.05	7.37	3	0.95
553060	FC 80 x 32	3.18	32	3.5	1.73	4.13	2.36	7.37	3	1.08
553070	FC 80 x 50	3.18	50	3.5	2.44	4.13	3.07	7.37	3	1.41
568700	FC 100 x 32	3.97	32	4.29	1.73	4.92	2.36	7.37	3	1.47
568730	FC 120 x 32	4.4	32	5.08	1.73	5.70	2.36	7.37	3	1.67

## BC

### Ribbed-Steel Busbar Clamp

- Clamping capacity: 0.79 inches
- 2 ribbed zinc-plated hardened-steel plates complete with screws
- Maximum clamping capacity is 50 mm using longer screws SAE Grade 5
- UL® 67 recognized

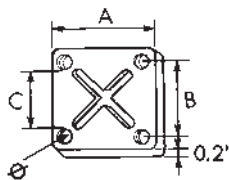

Article No.	Description	A in	B in	C in	Ø mm	Torque ft/lbs	⊠	lbs
553200	BC 30	2.2	1.65	1.37	M6	5.16	8	0.68
553210	BC 40	2.6	2.05	1.77	M6	5.16	8	0.81
553220	BC 50	3.26	2.52	2.16	M8	14.75	8	1.30
553230	BC 63	3.66	2.91	2.55	M8	14.75	4	1.63
553250	BC 80	4.64	3.78	3.34	M10	29.5	4	2.60
553260	BC 100	5.67	4.64	4.21	M10	29.5	4	3.79



## HCBC

### High Current Busbar Clamp

- Clamping capacity: 1.58 inches
- This modular busbar clamp is designed with non-magnetic materials for high current connections between Flexibar and rigid busbars such as transformer terminals
- Its mechanical design assures rigidity and even contact pressure
- Use 2 clamps to guarantee the contact pressure

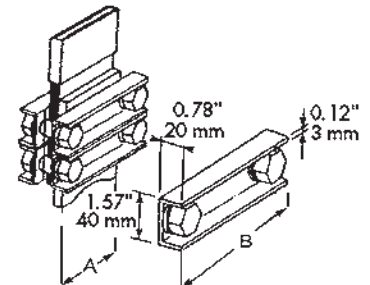

Article No.	Description	Busbar A in	Busbar B mm	Overall Width B in	Overall Bolt Length in	Torque ft/lbs	⊠	lbs
553100	HSBC 80	3.15	80	5.5	2.35	74	1	1.85
553110	HSBC 100	3.94	100	6.3	2.35	74	1	2.03
553120	HSBC 120	4.72	120	7.2	3.15	74	1	2.20

# Connecting Clamps and Accessories

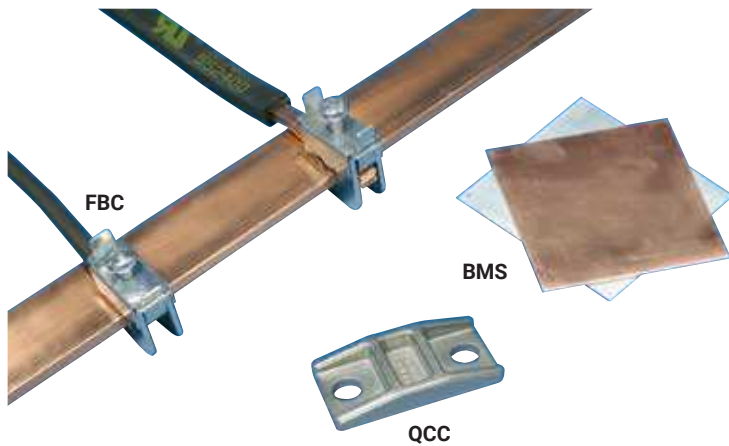

## FBC

### Connectors for Connecting without Drilling

- Very compact connector for connecting without drilling to a 5 or 10 mm thick busbar:
- Cables from 1 mm<sup>2</sup> up to 185 mm<sup>2</sup> or Flexibar width 6 to 20 mm
- Self-support of connector during mounting procedure
- IEC 60999

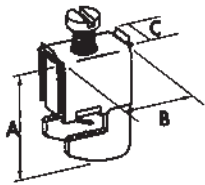

## FLEXIBAR TYPE

Connectors for busbars thickness 5 mm

Article No.	Description	A in	B in	C mm	Flexibar type	Torque N.m	Cable Size mm <sup>2</sup>		
553405	FBC 5 x 4	0.91	1.14	0.43		2	1-4	15	0.035
553400	FBC 5 x 6	1.10	1.22	0.55	6 mm	3	2.5-16	15	0.061
553410	FBC 5 x 9	1.41	1.57	0.74	9 mm	6-8	16-50	15	0.149
553510	FBC 5 x 15.5	1.73	1.57	0.98	15.5 mm	10-12	35-70	15	0.243
553520	FBC 5 x 20	1.88	1.57	1.22	20 mm	12-15	70-185	15	0.291

Connectors for busbars thickness 10 mm

Article No.	Description	A in	B in	C in	Flexibar type	Torque N.m	Cable Size mm <sup>2</sup>		
553505	FBC 10 x 4	1.10	1.14	0.47		2	1-4	15	0.039
553430	FBC 10 x 6	1.30	1.22	0.55	6 mm	3	2.5-16	15	0.066
553440	FBC 10 x 9	1.65	1.57	0.75	9 mm	6-8	16-50	15	0.154
553530	FBC 10 x 15.5	1.93	1.57	0.98	15.5 mm	10-12	35-70	15	0.247
553540	FBC 10 x 20	2.13	1.57	1.22	20 mm	12-15	70-185	15	0.304

## BMS

### Bimetal Plate

- For high performance contact between an aluminum busbar and a copper busbar.
- 70% aluminum - 30% copper

Article No.	Description	Size		
553080	BMS 100	100 x 100 x 1	10	0.13
553090	BMS 500	500 x 500 x 1	2	3.2

## QCC

### Clamps Flexibar

- For Flexibar thickness ≤ 5 mm = 1 clamp
- For Flexibar thickness > 5 mm = 2 clamps

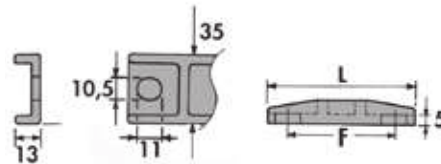

Article No.	Description	Flexibar width		L mm	F mm		
		min. in	max. in				
561210	QCC 15.5/32	0.59	1.26	2.75	1.97	5	0.247
561220	QCC 40/63	1.57	2.48	3.74	2.95	5	0.348

# nVent ERIFLEX Connecting, Earthing and Neutral Busbars



nVent ERIFLEX Connecting, Earthing and Neutral Busbars range are used to connect several earthing conductors within a panel and can be used in a variety of different applications including switchgear and control equipment, electrical equipment, wind and solar power generation and data centers.

Some bars can be used as power distribution bars or be used to collect DC current from Solar Panels.

nVent ERIFLEX Connecting, Earthing and Neutral Busbars range offers solutions for a wide variety of applications:

- Bars made of different materials such as Tinned aluminum, Brass, Nickel plated Brass and Copper
- Wide range of different fixed lengths, or ability to be cut to length if desired
- Many connection possibilities ranging from 2 to 260 conductors on the same bar

- A variety of conductor cross sections ranging from 1.5mm<sup>2</sup> (#16) to 50mm<sup>2</sup> (#1/0)
- A large range of mounting support which can be for insulation or conductors, for DIN rail or mounting plates and for one or two bars
- Meets worldwide standards with IEC and/or UL certification

# Universal Connecting Bars

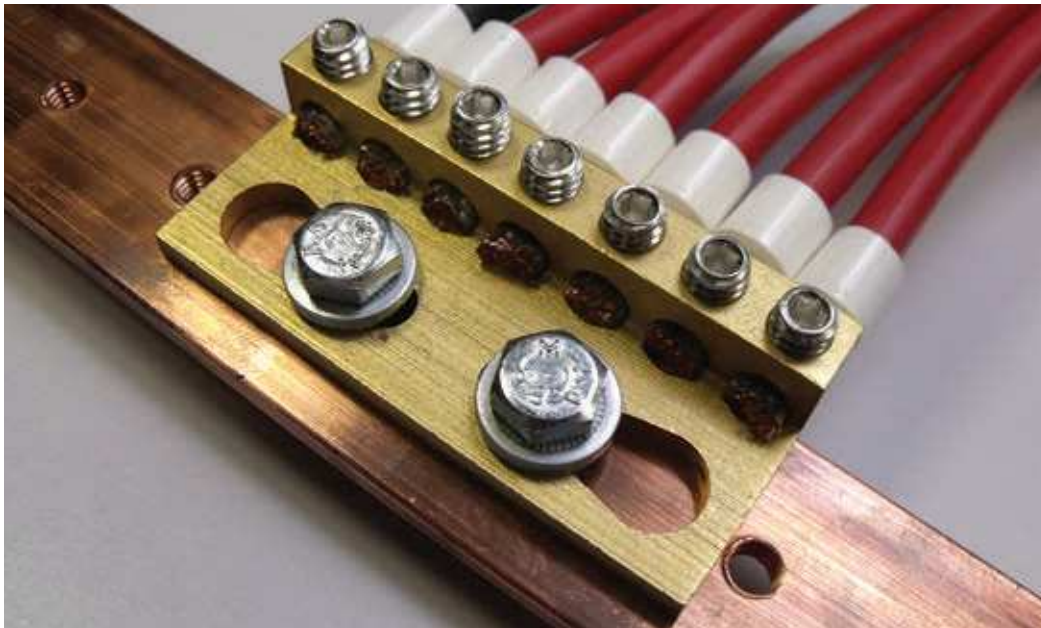

## UNIVERSAL CONNECTING BAR



### CB 7x16<sup>2</sup> - 450A

- Offers a current rating up to 450A
- Easy to wire with a hexagonal key
- Allows visual inspection of wire and confirmation of connection
- For use with punched or threaded copper busbar
- Can connect up to seven 1.5 to 16 mm<sup>2</sup> cables
- High fill ratio allows output connection with or without terminal
- Features high-conductivity brass material
- UL Listed for grounding applications

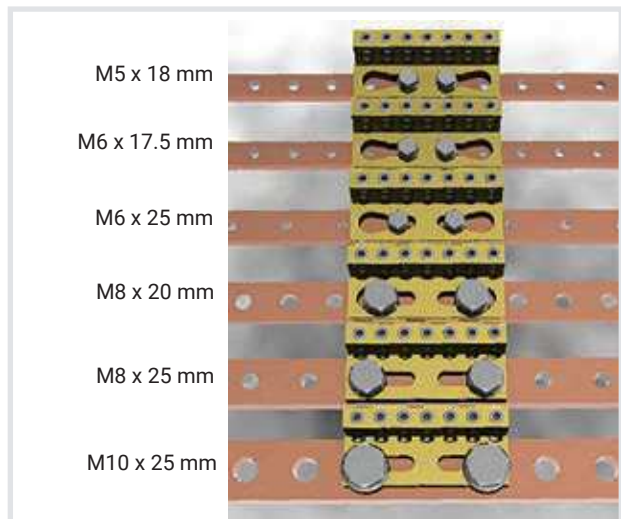
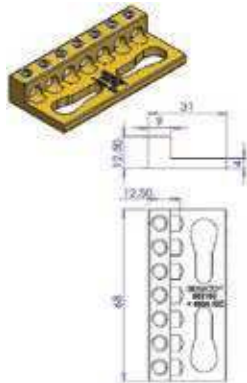

Article No.	Description	Diameter in	Box	lb
553150	CB 7x16 <sup>2</sup>	0.27	10	0.18

Metric mm <sup>2</sup>	Imperial AWG	Terminal	Terminal	r <sup>2</sup> (N.m)	Torque inch/lbs	Terminal
1.5	16	with terminal	without terminal, rigid cable	3.5	31	Terminal

The connecting bar is a 450 A power distribution bar that is designed to be connected to threaded or perforated copper or tinned aluminum busbar. Part of the nVent ERIFLEX line of low-voltage power distribution products from nVent, this compact system is only 68 mm long and allows for the connection of up to seven 1.5 to 16 mm<sup>2</sup> output cables.

Featuring high-conductivity brass material, the connecting bar is quick and easy to install, requiring only two M5 to M10 screws with a pitch from 18 mm to 25 mm. The hexagonal key helps simplify wiring, and the convenient design allows visual inspection of the wire and confirmation of the connection. The high fill ratio allows an output connection with or without a terminal.

# CB Connecting Bars

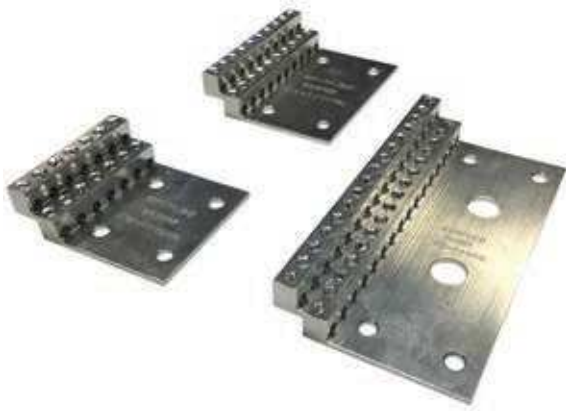

## FEATURES

- Ideal for solar applications
- Tinned aluminum bar allows for copper or aluminum conductor connections
- Design allows for visual inspection of conductor and confirmation of connection
- Can be fixed on standoff insulators or punched or threaded copper busbar
- High fill ratio allows output connection with or without terminal

Material: Aluminum  
Finish: Tinned



Description	CB14X10AL	CB20X10AL	CB32X10AL
Article Number	553152	553153	553151
Max Current Rating, IEC	450 A	640 A	1 020 A
Number of Connections	14	20	32
Conductor Size, IEC	(14) 1.5–6 mm <sup>2</sup> Stranded	(20) 1.5–6 mm <sup>2</sup> Stranded	(32) 1.5–6 mm <sup>2</sup> Stranded
Ferrule Conductor Size, IEC	(14) 2.5–6 mm <sup>2</sup>	(20) 2.5–6 mm <sup>2</sup>	(32) 2.5–6 mm <sup>2</sup>
Conductor Size, UL	(14) #14 - #6 Solid (14) #16 - #6 Stranded	(20) #14 - #6 Solid (20) #16 - #6 Stranded	(32) #14 - #6 Solid (32) #16 - #6 Stranded
Depth (D)	0.87 in		
Height (H)	2.83 in		
Width (W)	2.40 in	3.46 in	5.55 in
Thickness (T)	0.08 in		
Hole Size 1 (HS1)	0.24 in		
Hole Size 2 (HS2)	–		0.51 in
A	0.35 in		
B	1.22 in		
C	1.42 in	2.47 in	4.8 in
E	–		1.73 in
Torque (TQ)	2 N-m		
Unit Weight	0.154 lb	0.220 lb	0.352 lb
Complies With	IEC® 60947-1 IEC® 60998-2-1, UL		
Packing Unit	10pc		

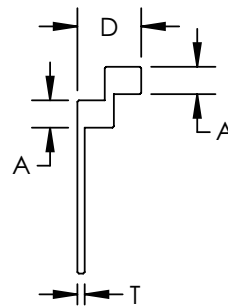
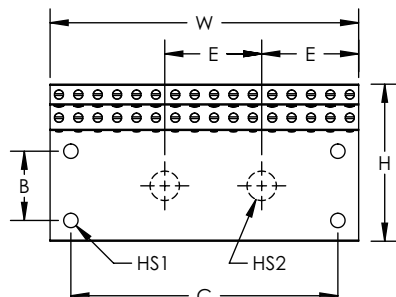

# Grounding Parts

EB 60  
EB 20  
EB 44

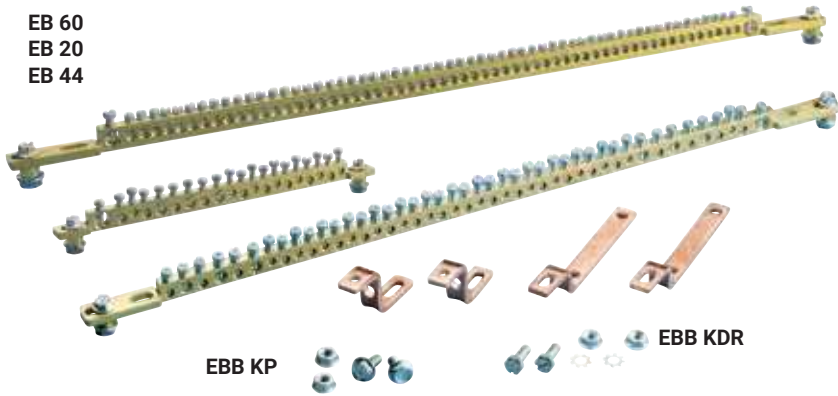

- Universal fixing
- Numerous connections
- Easy connections due to chamfer
- Rigid bar
- High conductivity brass quality
- Copper Brackets kit for easy fixing
- UL Listed for grounding applications



## Fixing on Copper Bar

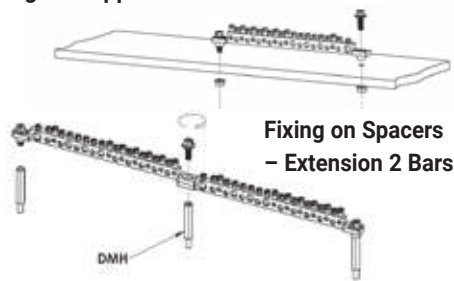

## Direct Fixing

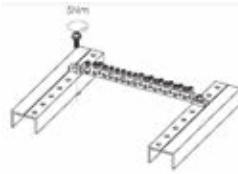

Ø				EB20	EB44	EB60
0.36 in	8-6 AWG	6-4 AWG	17 in-lbs	x 1	x 1	x 1
0.28 in	12-6 AWG	12-4 AWG	17 in-lbs	x 3	x 6	x 1
0.21 in	14-8 AWG	14-8 AWG	13 in-lbs	x 9	x 21	
0.18 in	16-10 AWG	14-10 AWG	17 in-lbs	x 7	x 17	x 58

Article No.	Description	L		
568660	EARTH BAR EB 44	462	1	0.66
568661	EARTH BAR EB 60	462	1	0.68
568662	EARTH BAR EB 20	215	1	0.42

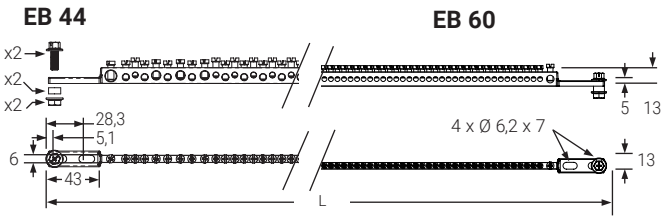
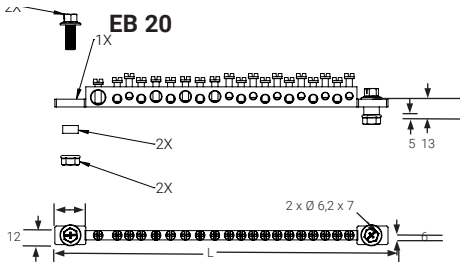

## Fixing on DIN Rail Using EBB KDR Kit 568665

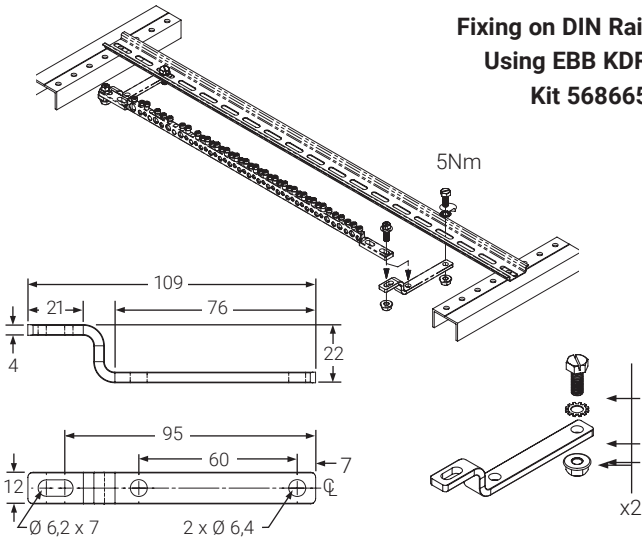

## Fixing 2 Bars Using EBB KP Kit 568666

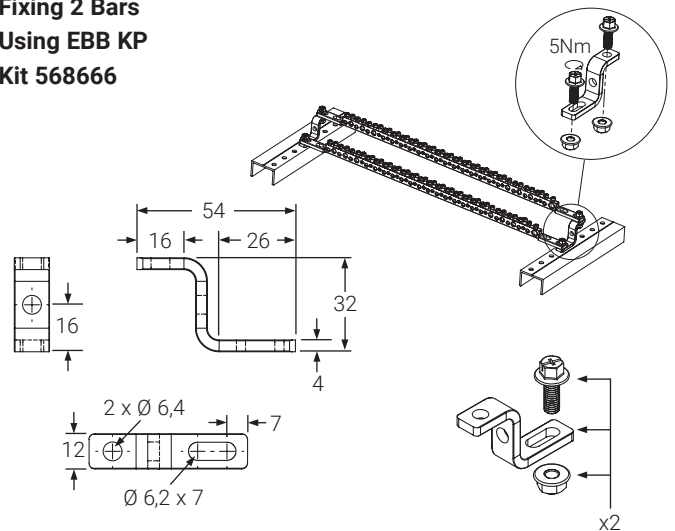

Article No.	Description		
568665	EBB KDR KIT DIN RAIL	1	0.14

Article No.	Description		
568666	EBB KDR KIT PLATE	1	0.22

# Grounding Parts

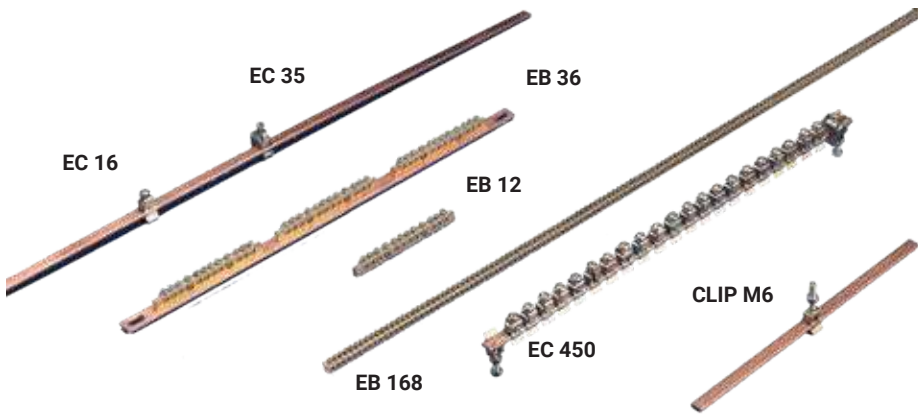

- Quick and easy connections
- Large and versatile range
- Connections: from 2.5 to 35 mm<sup>2</sup>



## EC

### Earthing Connectors

- For plain bars 12 x 4 and 12 x 5 with rounded corners
- Conductor is clamped through a pressure plate
- Connectors will slide and self-support before fixing of conductor
- Single screw locks clamp and makes connection
- Connections can be added after bar has been mounted

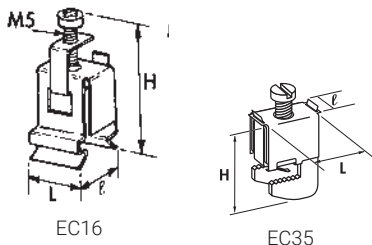

16 mm<sup>2</sup> flexible cable  
35 mm<sup>2</sup> rigid cable

Article No.	Description	L in	I in	H in		
553460	EC 16 <sup>c</sup> -4	0.67	0.55	1.5	20	0.022
553480	EC 16 <sup>c</sup> -5	0.67	0.55	1.5	20	0.022
553470	EC 35	1.22	0.43	1.06	20	0.055

## EB

### Earthing and Neutral Busbar

- EB 12: earthing brass busbar 13 x 6 for 10 connections 16 mm<sup>2</sup> and 2 connections 35 mm<sup>2</sup>
- EB 36: earthing copper busbar 15 x 4 equipped with 3 EB12
- EB 168: earthing brass busbar 8 x 8 for 168 connections 10 mm<sup>2</sup>

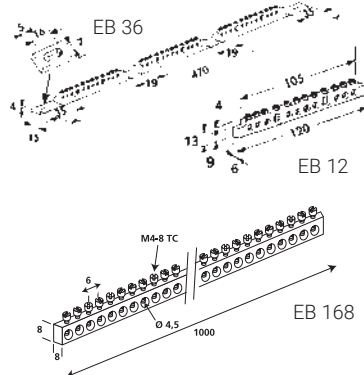

Article No.	Description		
568610	EB 12	10	0.15
568611	EB 12	200	0.15
568620	EB 36	10	1.00
568630	EB 168	10	1.00

## KIT EC 450

### Earthing Kit

- Plain bar 12 x 4 x 475 mm long
- 1 connector 35 mm<sup>2</sup>
- 20 connectors 16 mm<sup>2</sup> + 2 mounting clips

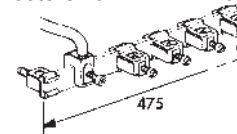

Article No.	Description		
562100	KIT EC 450	1	0.80

## CLIP M6

### Mounting Clip

- For plain bars 12 x 4 and 12 x 5

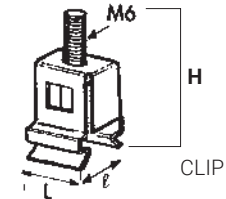

Article No.	Description	L in	I in	H in		
553450	CLIP M6-4	0.67	0.55	1.50	20	0.022
553490	CLIP M6-5	0.67	0.55	1.5	20	0.022

## MBJ



## BJ

Article No.	Description	Intensity A	Thick in	Section mm <sup>2</sup>	L in	Ø in	J in	T in		
563410	MBJ 6-200-6	40	0.04	6	2.87	0.24	0.511	0.9	10	0.037
556640	MBJ 16-200-8	120	0.039	16	2.87	0.31	0.59	0.98	10	0.073
556740	MBJ 30-200-10	180	0.08	30	7.87	0.394	0.90	1.3	10	0.137

Article No.	Description	Section mm <sup>2</sup>	L in	Ø D in	Intensity A		
556910	BJ 6-200 S	6	7.87	0.24	45	10	0.033

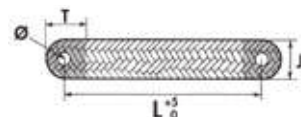
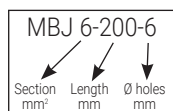

Round braids with crimped lugs

# EB-142 and EB-166 Earthing and Neutral Busbar & Accessories



## FEATURES

- Use to connect several earthing conductors
- Chamfered holes allow for easy connections
- Nickel plating is corrosion resistant
- Rigid bar
- Cut to length as needed
- Quick and easy installation
- RoHS compliant

Material: Brass  
Finish: Nickel Plated



Description	EB142	EB166
Article Number	568668	568667
Number of Connections	142	166
Conductor Size, IEC	1.5 - 16 mm <sup>2</sup> Stranded	1.5 - 10 mm <sup>2</sup> Stranded
Max Current Rating	63 A	40 A
Cross Section	80 mm <sup>2</sup>	64 mm <sup>2</sup>
Depth (D)	0.31 in	
Height (H)	0.39 in	0.31 in
Width (W)	39.37 in	
Hole Size (HS)	0.20 in	0.157 in
Thread Size (TS)	M5	M4
A	0.275 in	0.24 in
Torque (TQ)	2.0 N-m	1.2 N-m
Unit Weight	1.285 lb	1.03 lb
Complies With	IEC® 60998-2-1	
Packing Unit	10pc	

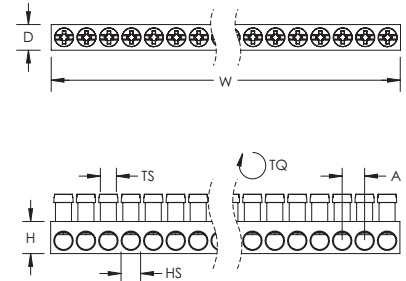

## EB-142/166 SINGLE NEUTRAL BUSBAR SUPPORT

- Provides support for one EB-142 or EB-166 Earthing and Neutral Busbar
- Quick and easy installation
- Halogen free
- RoHS compliant



Description	Article Number	Packing Unit
EB142-166SUP1	568669	10pc

## EB-142/166 DUAL NEUTRAL BUSBAR SUPPORT

- Provides support for two EB-142 or EB-166 Earthing & Neutral Busbars
- Quick and easy installation
- Halogen free
- RoHS compliant



Description	Article Number	Packing Unit
EB142-166SUP2	568670	10pc

## EB-142 MAIN TERMINAL CLAMP

- For conductor up to 35mm<sup>2</sup>



Description	Article Number	Packing Unit
EB142CON35	568672	10pc

## EB-166 MAIN TERMINAL CLAMP

- For conductor up to 25mm<sup>2</sup>

Description	Article Number	Packing Unit
EB166CON25	568671	10pc

# EB-130 and EB-2X130 Earthing and Neutral Busbar & Accessories



## FEATURES

- Use to connect several earthing conductors
- Chamfered holes allow for easy connections
- Nickel plating is corrosion resistant
- Rigid bar
- Cut to length as needed
- Quick and easy installation
- RoHS compliant

Material: Brass  
Finish: Nickel Plated



Description	EB130	EB2X130
Article Number	568673	568674
Number of Connections	130	260
Conductor Size, IEC	1.5 - 25 mm <sup>2</sup> Stranded	1.5 - 25 mm <sup>2</sup> Stranded
Max Current Rating	125 A	200 A
Cross Section	150 mm <sup>2</sup>	225 mm <sup>2</sup>
Depth (D)	0.59 in	0.59 in
Height (H)	0.39 in	0.59 in
Width (W)	39.37 in	39.37 in
Hole Size (HS)	0.24 in	0.24 in
Thread Size (TS)	M5	M5
A	0.27 in	0.27 in
Torque (TQ)	2 N-m	2 N-m
Unit Weight	2.28 lb	3.50 lb
Complies With	IEC® 60998-2-1	IEC® 60998-2-1
Packing Unit	5pc	1pc

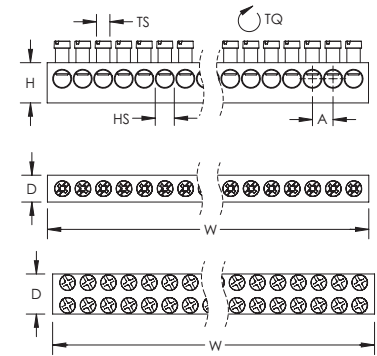

## EB-130 DUAL NEUTRAL BUSBAR SUPPORT

- Provides support for two EB-130 or EB-2X130 Earthing and Neutral Busbars
- Quick and easy installation
- Halogen free
- RoHS compliant



Description	Article Number	Packing Unit
EB130SUP2	568675	10pc

## EB-130 MAIN TERMINAL CLAMP

- For use with EB-130 or EB-2X130 Earthing and Neutral Busbars
- Quick and easy installation
- RoHS compliant
- For conductor up to 35mm<sup>2</sup>
- For conductor up to 70mm<sup>2</sup>



Description	Article Number	Packing Unit
EB130CON35	568676	10pc
EB130CON70	568677	10pc

# Earthing and Neutral Busbars with Green/Yellow DIN Rail Clip

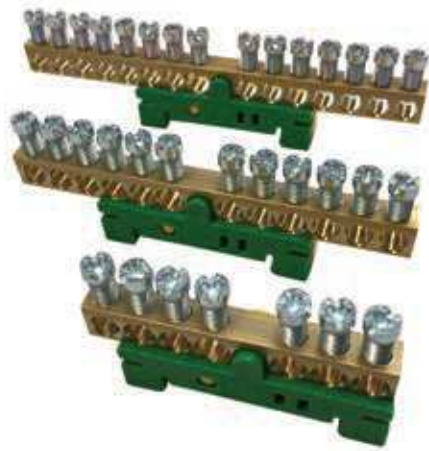

## FEATURES

- Use to connect several earthing conductors
- Easy for the installer to add connections
- Chamfered holes allow for easy connections
- Rigid bar
- Quick and easy installation on DIN rail
- Halogen free

Material: Brass; Polyethylene



Description	EB7GYSUP	EB12GYSUP	EB15GYSUP
Article Number	568678	568679	568680
Number of Connections	7	12	15
Conductor Size, IEC	(1) 6 - 25 mm <sup>2</sup> Stranded (6) 1.5 - 16 mm <sup>2</sup> Stranded	(1) 6 - 25 mm <sup>2</sup> Stranded (11) 1.5 - 16 mm <sup>2</sup> Stranded	(1) 6 - 25 mm <sup>2</sup> Stranded (14) 1.5 - 16 mm <sup>2</sup> Stranded
Max Current Rating	40 A		
Cross Section	63 mm <sup>2</sup>		
Depth (D)	0.27 in		
Height (H)	0.35 in		
Width (W)	2.24 in	3.62 in	4.45 in
Hole Size 1 (HS1)	0.24 in		
Hole Size 2 (HS2)	0.20 in		
Thread Size (TS)	M5		
Torque (TQ)	2 N-m		
Unit Weight	0.066 lb	0.103 lb	0.125 lb
Complies With	IEC® 60998-2-1		
Packing Unit	10pc		

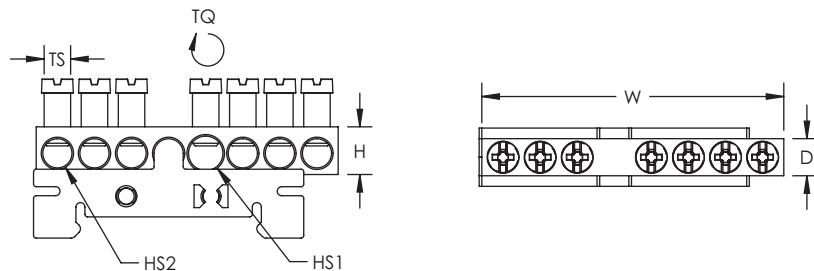

# EBC-133 Earthing and Neutral Busbars



## FEATURES

- Easy for the installer to add connections
- Clamps are fully assembled
- Clamps follow the screw vertically, making it quick and easy to mount the conductor
- Cut to length as needed
- Main terminal clamp available for thicker conductors
- Can be connected to IBSB25 Insulated Braided Conductor, MBJ Grounding and Bonding Braid, and nVent ERIFLEX Flexibar up to 9 mm (0.354")
- Quick and easy installation
- RoHS compliant

Material: Copper; Steel  
Finish: Electrogalvanized



Description	EBC133-10X3X2000	EBC133-15X5X2000
Article Number	568612	568613
Number of Connections	133	
Conductor Size, IEC	(133) 0.5 - 16 mm <sup>2</sup> Solid (133) 0.5 - 10 mm <sup>2</sup> Stranded	
Conductor Width	9 mm Max	
Max Current Rating	108 A	218 A
Cross Section	30 mm <sup>2</sup>	75 mm <sup>2</sup>
Depth (D)	0.39 in	0.59 in
Width (W)	78.74 in	
Thickness (T)	0.12 in	0.2 in
A	0.59 in	
B	0.16 in	0.24 in
Thread Size (TS)	M5	
Torque (TQ)	2.5 N-m	4.5 N-m
Unit Weight	2.2 lb	3.97 lb
Packing Unit	1pc	

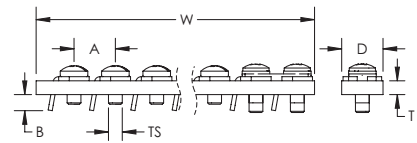

## EBC-133 MAIN TERMINAL CLAMP KIT

- Kit includes 10 clamps and 20 screws
- Used to connect thicker conductors including IBSB25 Insulated Braided Conductor, MBJ Grounding and Bonding Braid, and nVent ERIFLEX Flexibar up to 9 mm (0.354")
- For conductors from 16 to 35mm<sup>2</sup>
- Quick and easy installation
- RoHS compliant

Description	Article Number	Packing Unit
KIT-EBC133-15	568614	10pc

# Tinned Aluminum Earthing and Neutral Busbars



## FEATURES

- Tinned aluminum bar allows for copper or aluminum conductor connections
- Use to connect several earthing conductors
- Chamfered holes allow for easy connections
- Tin plating is corrosion resistant
- Rigid bar
- Can be fixed using IRS Angle Support Bracket, DMH Metallic Spacer or DH Distance Holder and Spacer
- Quick and easy installation
- RoHS compliant

Material: Aluminum  
 Finish: Tinned  
 Certification Details: UL® 467



Description	EB2AL	EB4AL	EB6AL	EB10AL	EB12AL	EB20AL
Article Number	568710	568711	568712	568713	568714	568715
Number of Connections	2	4	6	10	12	20
Number of Holes	3	6	8	12	14	22
Conductor Size, IEC	2.5 - 16 mm <sup>2</sup> Stranded					
Conductor Size, UL	#14 - #4 Stranded					
Max Current Rating	85 A					
Height (H)	0.43 in					
Width (W)	0.95 in	1.85 in	2.56 in	3.78 in	4.41 in	6.93 in
Depth (D)	7.9 mm					
Unit Weight	0.007 lb	0.013 lb	0.037 lb	0.057 lb	0.066 lb	0.10 lb
Packing Unit	20 pc					

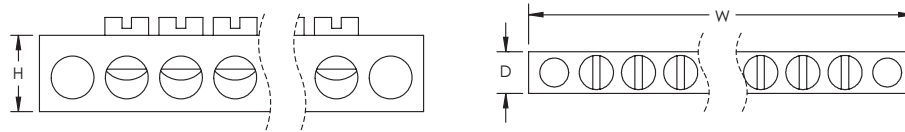

# Tinned Aluminum Earthing and Neutral Double Busbars



## FEATURES

- Tinned aluminum bar allows for copper or aluminum conductor connections
- Use to connect several earthing conductors
- Chamfered holes allow for easy connections
- Tin plating is corrosion resistant
- Rigid bar
- Can be fixed using IRS Angle Support Bracket, DMH Metallic Spacer or DH Distance Holder and Spacer
- Quick and easy installation
- RoHS compliant

Material: Aluminum  
Finish: Tinned



Description	EBD8AL	EBD10AL	EBD14AL	EBD20AL
Article Number	568716	568717	568718	568719
Number of Connections	8	10	14	20
Conductor Size, IEC	(1) 16 - 35 mm <sup>2</sup> Stranded (4) 6 - 10 mm <sup>2</sup> Stranded (3) 1.5 - 6 mm <sup>2</sup> Stranded	(1) 16 - 35 mm <sup>2</sup> Stranded (5) 6 - 10 mm <sup>2</sup> Stranded (4) 1.5 - 6 mm <sup>2</sup> Stranded	(1) 16 - 35 mm <sup>2</sup> Stranded (7) 6 - 10 mm <sup>2</sup> Stranded (6) 1.5 - 6 mm <sup>2</sup> Stranded	(1) 16 - 35 mm <sup>2</sup> Stranded (1) 16 - 50 mm <sup>2</sup> Stranded (9) 1.5 - 6 mm <sup>2</sup> Stranded (9) 6 - 10 mm <sup>2</sup> Stranded
Conductor Size, UL	(1) #4 - #2 Stranded (3) #16 - #10 Stranded (4) #8 - #6 Stranded	(1) #4 - #2 Stranded (4) #16 - #10 Stranded (5) #8 - #6 Stranded	(1) #4 - #2 Stranded (6) #16 - #10 Stranded (7) #8 - #6 Stranded	(1) #1 - #1/0 Stranded (1) #4 - #2 Stranded (9) #16 - #10 Stranded (9) #8 - #6 Stranded
Max Current Rating	115 A			
Height (H)	0.47 in			
Width (W)	2.48 in	2.99 in	3.50 in	4.84 in
Depth (D)	0.47 in			
Unit Weight	0.075 lb	0.08 lb	0.106 lb	0.148 lb
Certification Details	UL® 486A, UL® 486B			
Packing Unit	10pc			

Description	EBD26AL	EBD34AL	EBD44AL
Article Number	568720	568721	568722
Number of Connections	26	34	44
Conductor Size, IEC	(1) 16 - 35 mm <sup>2</sup> Stranded (1) 16 - 50 mm <sup>2</sup> Stranded (12) 1.5 - 6 mm <sup>2</sup> Stranded (12) 6 - 10 mm <sup>2</sup> Stranded	(1) 16 - 35 mm <sup>2</sup> Stranded (1) 16 - 50 mm <sup>2</sup> Stranded (16) 1.5 - 6 mm <sup>2</sup> Stranded (16) 6 - 10 mm <sup>2</sup> Stranded	(1) 16 - 35 mm <sup>2</sup> Stranded (1) 16 - 50 mm <sup>2</sup> Stranded (21) 1.5 - 6 mm <sup>2</sup> Stranded (21) 6 - 10 mm <sup>2</sup> Stranded
Conductor Size, UL	(1) #1 - #1/0 Stranded (1) #4 - #2 Stranded (12) #8 - #6 Stranded (12) #16 - #10 Stranded	(1) #1 - #1/0 Stranded (1) #4 - #2 Stranded (16) #8 - #6 Stranded (16) #16 - #10 Stranded	(1) #1 - #1/0 Stranded (1) #4 - #2 Stranded (21) #16 - #10 Stranded (21) #8 - #6 Stranded
Max Current Rating	150 A		
Height (H)	0.47 in		
Width (W)	5.87 in	7.36 in	9.01 in
Depth (D)	0.47 in		
Unit Weight	0.18 lb	0.22 lb	0.27 lb
Certification Details	UL® 486A, UL® 486B		
Packing Unit	10pc		

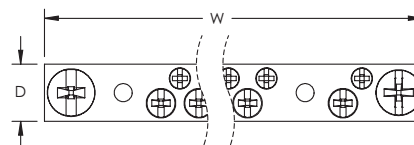
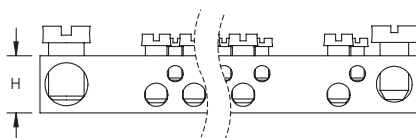

# Busbar Supports

## FLAT BUSBAR SUPPORTS (METRIC)

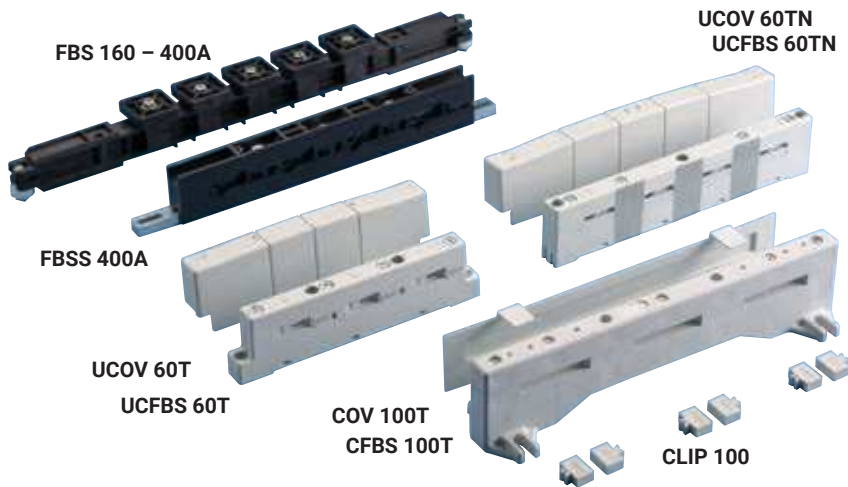

- Universal versatile support
- Minimum space requirement
- Working temperature: -40°C up to 130°C
- Self extinguishing UL® 94 VO

### FBS

#### 160 – 400A

- For threaded bars 15-20-32 x 5 mm, 3 phase & neutral circuit
- Plastic positioning pin for bar location
- A screen can be fixed using spacers
- An earth can be mounted on either right or left side
- Halogen free

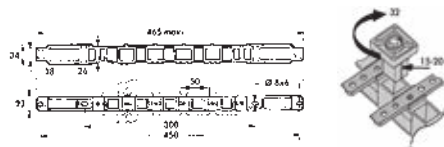

Article No.	Description	Bar width mm	Bar thickness mm		kg
551350	FBS 400A	15-20-32	5	1	0.30

### FBSS

#### 400A

- For bars 32 x 5 without drilling
- Easy connection (inclined bars)
- Adjustable arms for an easy mounting and M6 screw included in the packaging
- Provision for fixing protective screen with self-tapping screws
- Halogen free

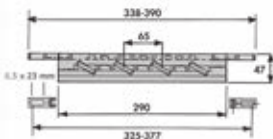

Article No.	Description		kg
551190	FBSS 32 x 5	2	0.316

### UCFBS 60 T-TN

#### 160 – 630A

- Bar thickness 5 & 10 mm
- Versatile support for bars 15, 20, 25 and 30 mm
- UL 94 VO
- Max. temp.: 130°C
- End cover 562710 and 562760 to cover busbar ends

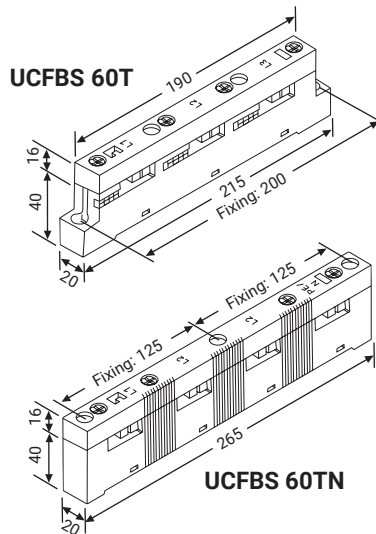

Article No.	Description				kg
562700	UCFBS 60 T	15-30 x 5	15-30 x 10	4	0.190
562710	UCOV 60 T			2	0.028
562750	UCFBS 60 TN	15-30 x 5	15-30 x 10	4	0.262
562760	UCOV 60 TN			2	0.034

### CFBS 100 T

#### 630 – 1200A

- Bar thickness 10 mm
- Versatile support for bars 30, 40, 50 and 60 – using the clips
- UL 94 VO
- Max. temp.: 130°C
- End cover 562810 to cover busbar ends

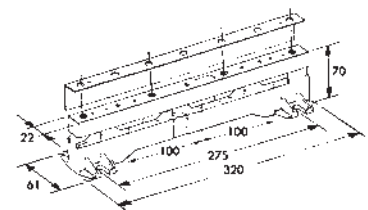

Article No.	Description		Number clip per phase		kg
562800	CFBS 100T	60 x 10		4	0.436
562810	COV 100T			10	0.050
562830	CLIP 100 40 x 10	40 x 10	2	24	0.004
562840	CLIP 100 50 x 10	50 x 10	2	24	0.002

# Busbar Supports

## ADJUSTABLE FLAT BUSBAR SUPPORTS (METRIC)

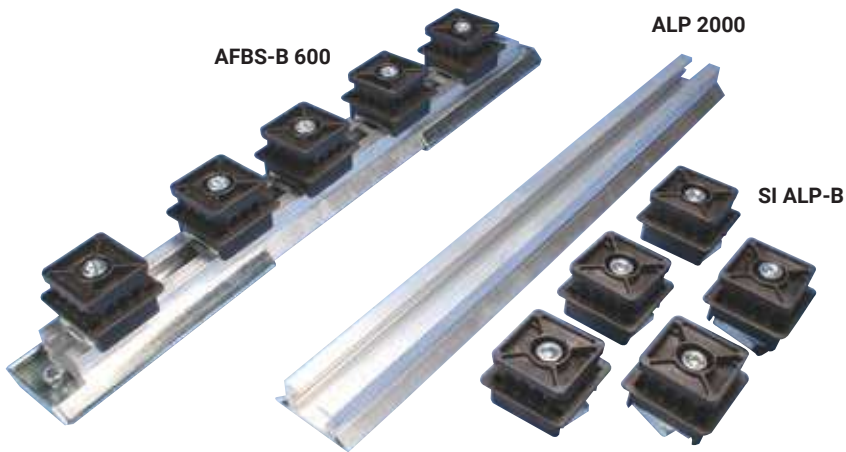

- Adjustable distance between phases
- Quick adjustment to busbar thickness 5 or 10 mm
- High resistance to short-circuit forces
- Excellent security of equipment
- Universal fixing
- Working temperature: -40°C up to 130°C
- Self extinguishing UL® 94 V0

### AFBS-B 600

#### UP TO 1600A

- Versatile support for bars 30 to 80 mm
- For busbar thickness: 5 or 10 mm
- 3 phase + neutral circuit
- Halogen free
- See below for some applications

#### AFBS 600

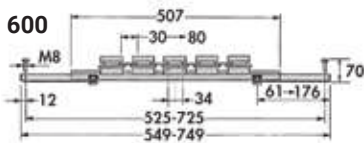

### AFBS

#### UP TO 2300A

- Versatile support for bars 30 to 125 mm to build with:  
ALP 2000 aluminium rail length 2000 mm + SI ALP-B insulator blocks
- 3 phase + neutral circuit
- For busbar thickness 5 or 10 mm
- Halogen free



Article No.	Description		
504971	AFBS-B 600	1	2.200

Article No.	Description		
504980	ALP 2000	2	2.950
504991	SI ALP-B	12	0.258

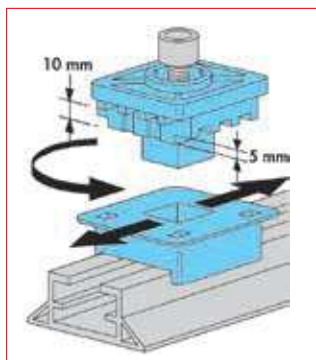
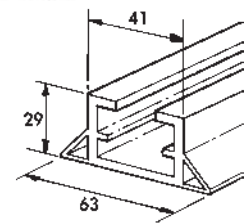

Slide and adjust to busbar thickness (5 or 10 mm) by simply rotating the insulator.

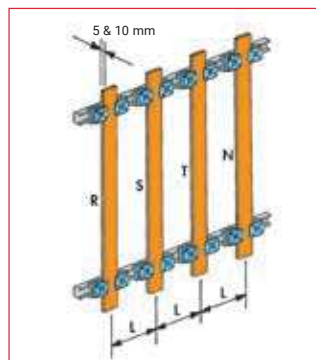

2 insulators per bar. Distance between phases can be adjusted by sliding. See nVent ERIFLEX Software.

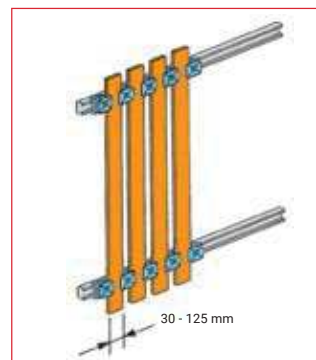

1 insulator can support 2 bars. Fixed distance between bars: 34 mm.

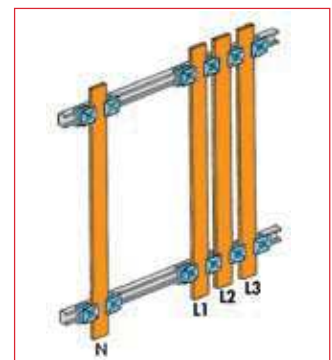

The 2 applications can be combined.

# Busbar Supports

## COMPACT AND REINFORCED BUSBAR SUPPORTS (METRIC)

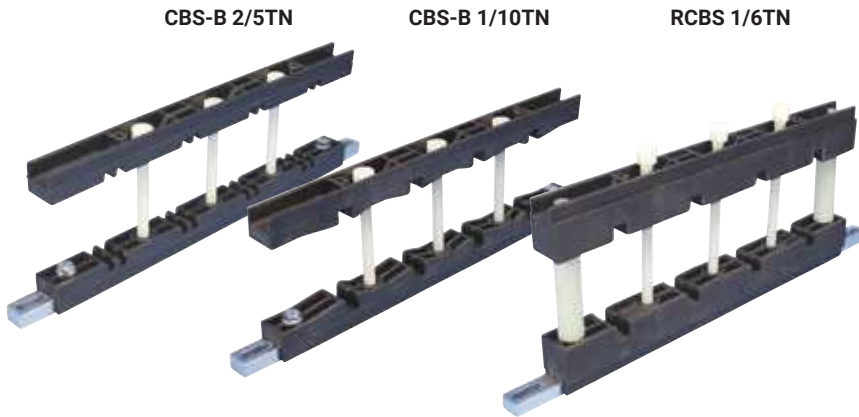

- Minimum space requirement
- Easy and quick assembly
- Fits within 400 mm depth panelboard
- Provision for direct fixing of a screen
- Halogen free
- Working temperature  $-40^{\circ}\text{C}$  up to  $130^{\circ}\text{C}$
- Self extinguishing UL<sup>®</sup> 94 V0

### CBS-B 2/5TN

250-1600A

- For bar thickness 5

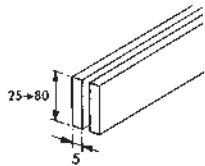
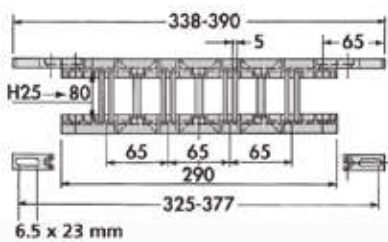

Article No.	Description	Bar thickness mm	Busbars per phase	kg
551151	CBS-B 2/5 TN	5	2	0.200

### CBS-B 1/10TN

250-1600A

- For bar thickness 10 mm

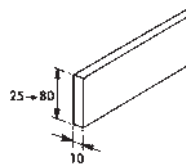
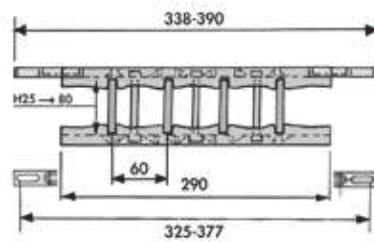

Article No.	Description	Bar thickness mm	Busbars per phase	kg
551181	CBS-B 1/10 TN	10	1	0.260

### RCBS 1/6TN-1/10TN

Mechanically Reinforced

- Distance between copper bars and frame: 24 mm

- RCBS 1/6TN
- 500-1200A
- for bar thickness: 6.35 mm

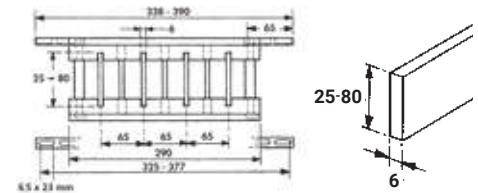

Article No.	Description	Bar thickness mm	Number of Busbars per phase	kg
552050	RCBS 1/6 TN*	6	1	0.650

- RCBS 1/10TN
- 500-1600A
- for bar thickness: 10 mm

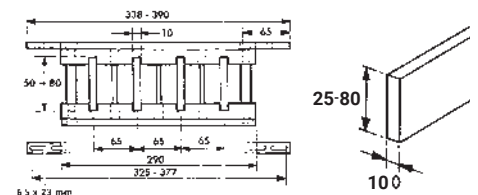

Article No.	Description	Bar thickness mm	Number of Busbars per phase	kg
552070	RCBS 1/10 TN*	10	1	0.620

# Busbar Supports

## COMPACT AND ADJUSTABLE BUSBAR SUPPORTS (METRIRC)

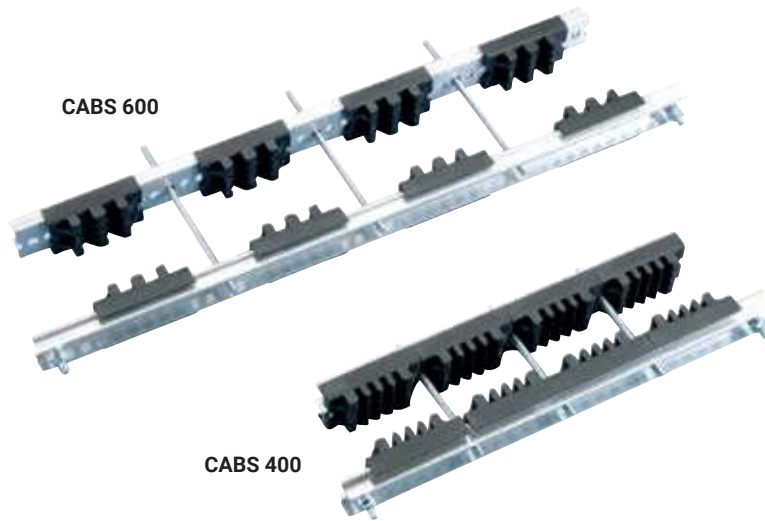

- Universal fixing support
- Easy to install
- Adjustable distance between each phase (12.5 mm pitch)
- Standard or customised support
- Cost-effective
- For all busbar types and nVent ERIFLEX Erilink busducts
- Halogen Free
- Working temperature: -40°C up to 130°C
- Self extinguishing UL® 94 V0



Bureau VERITAS  
Certificate No. 419419 / DO BV for  
shipboard use



### TECHNICAL FEATURES

- Panels: 300 to 800 mm
- Bars: 30 to 125 mm
- Thickness: 5 or 10 mm
- From 400A up to 4500 A

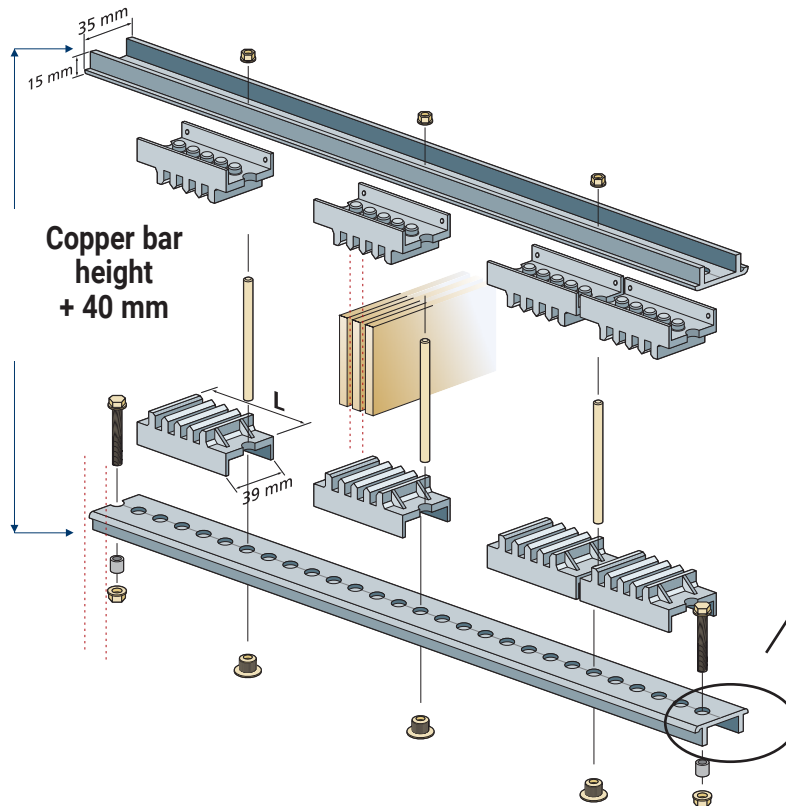

Aluminum Profile Rigidity  
How to improve the Bending  
Resistance, according to your  
configuration:

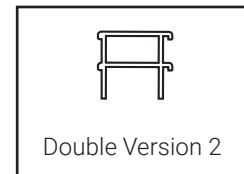
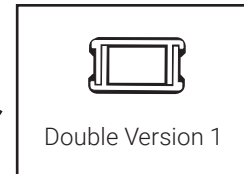
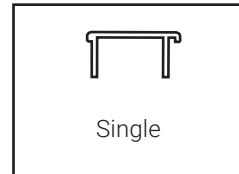

For calculation purpose:  
see nVent ERIFLEX Software

# Busbar Supports

## COMPACT AND ADJUSTABLE BUSBAR SUPPORTS (CABS) (METRIC)

### STANDARD CABS SUPPORTS READY TO USE:

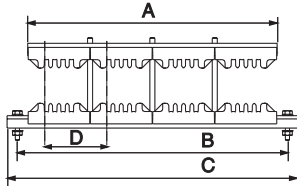

	CABS400	CABS600
A	300	500
B	325	525
C	350	550
D	75	75 → 125
4/5TN	549310	549260
2/10TN	549320	549270

Article No.	Description		kg	L
549310	CABS 4/5 TN 400	1	0.800	75
549320	CABS 2/10 TN 400	1	0.770	75
549260	CABS 4/5 TN 600	1	0.840	75
549270	CABS 2/10 TN 600	1	0.810	75

### CUSTOMIZED SUPPORT: JUST 3 PARTS

Less Parts... More Configurations:

#### 1 Aluminum Profile 2M (CABS App)

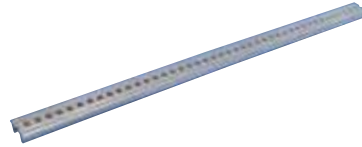

Article No.	Description		kg
549300	CABS APP	2	0.90

#### 2 6 CABS Modules:

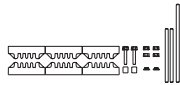

**CABS 4/5 T MODULE:**  
1 to 4 BARS  
30 → 125 x 5 mm

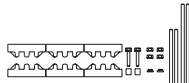

**CABS 2/10 T MODULE:**  
1 to 2 BARS  
30 → 120 x 10 mm

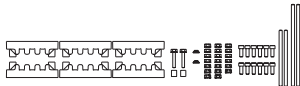

**CABS 3/10 T MODULE:**  
1 to 3 BARS  
30 → 120 x 10 mm

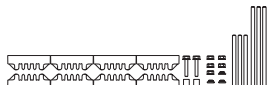

**CABS 4/5 TN MODULE:**  
1 to 4 BARS  
30 → 125 x 5 mm

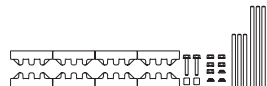

**CABS 2/10 TN MODULE:**  
1 to 2 BARS  
30 → 120 x 10 mm

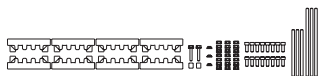

**CABS 3/10 TN MODULE:**  
1 to 3 BARS  
30 → 120 x 10 mm



T = 3 Phases

Article No.	Description		kg	L
549370	CABS 4/5 T MOD	1	0.39	75
549380	CABS 2/10 T MOD	1	0.37	75
549390	CABS 3/10 T MOD	1	0.45	100

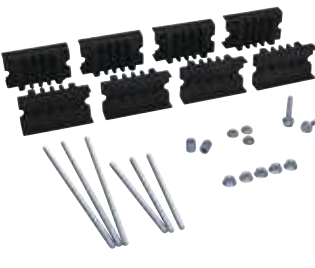

TN = 3 Phases + Neutral

Article No.	Description		kg	L
549340	CABS 4/5 TN MOD	1	0.50	75
549350	CABS 2/10 TN MOD	1	0.48	75
549360	CABS 3/10 TN MOD	1	0.58	100

#### 3 ACCESSORIES: BRACKETS FOR SUPPORTS FIXING

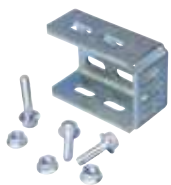

BRACKET CABS M



BRACKET CABS T KIT



BRACKET CABS E

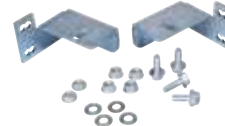

BRACKET CABS TH KIT



BRACKET CABS SV



BRACKET CABS RV



ADD. KIT CABS Fixing

Article No.	Description		kg
549450	CABS Bracket TH Kit	5	0.250
549470	CABS Bracket SV	10	0.050
549480	CABS Bracket RV	10	0.060
549400	CABS T SET	5	0.110
549410	CABS E	10	0.046
549420	CABS M	10	0.200
549430	ADD. Kit CABS Fixing	1	0.310

# Busbar Supports

## COMPACT AND ADJUSTABLE BUSBAR SUPPORTS (CABS)

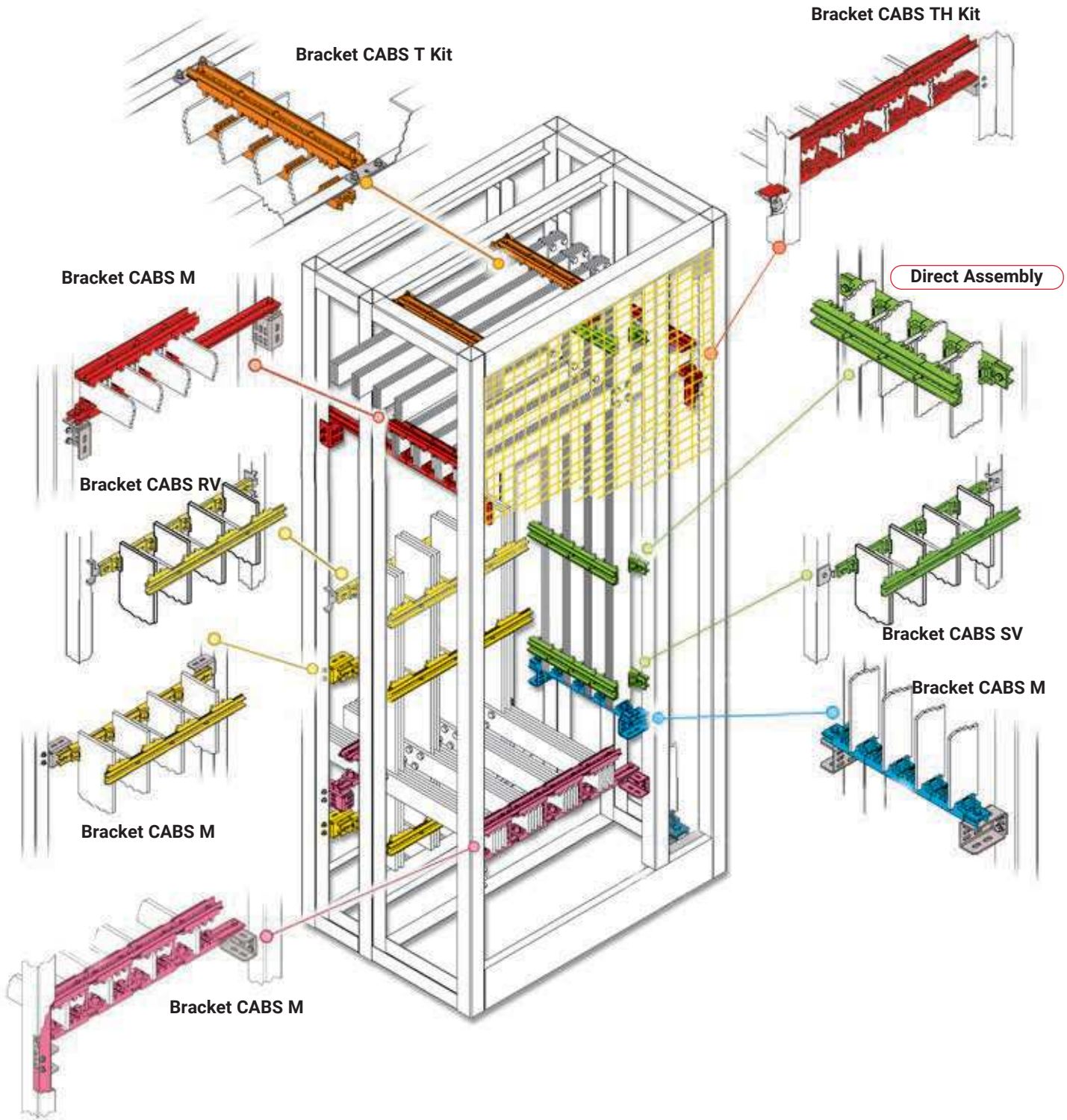

# Busbar Supports

## COMPACT ADJUSTABLE BUSBAR SUPPORTS, UL, IMPERIAL

Compact Adjustable Busbar Support (CABS), UL is an innovative and easy adjustable mounting solution for busbar supports. It provides a professional and standardized solution, while emphasizing the flexibility for multiple design configurations and providing a template for busbar supports. Compact Adjustable Busbar Support (CABS), UL is a time and cost saving product with UL recognition.

Added value by eliminating 'homemade' solutions for busbar supports by providing a professional and standardized solution, while emphasizing the flexibility for multiple design configurations and providing a template for busbar supports.



- Professional and standardized function and appearance
- Flexibility of CABS for multiple design situations including size, orientation, etc.
- Small form-factor and compact design for space savings
- Reduction of error possibility, correct creepage and clearance distance
- Complete off-the-shelf solution that retains potential for customization
- Allows customers to provide value to end-users while preserving existing design practices
- Time-savings
- Lower total installed cost

### CERTIFICATIONS



#### Compact Adjustable Busbar Support (CABS) Imperial

- UL Recognition and Listed for many UL standards
  - Compliance for requirements of spacing, material flammability and dielectric strength.
- Category QEUY2/QEUY8, which includes:
  - UL 67, panelboards (CSA C22.2 No. 29), up to 600V
  - UL 891, switchboards (CSA C22.2 No. 244), up to 600V
- Spacing also complies with:
  - UL 508A, industrial control panels, up to 600V feeder circuits
  - UL 845, motor control centers, up to 600V
  - UL 508C, power conversion equipment, up to 1000V
  - UL 1741, inverters, converters, controllers and interconnection
  - System equipment for use with distributed energy resources, up to 600V

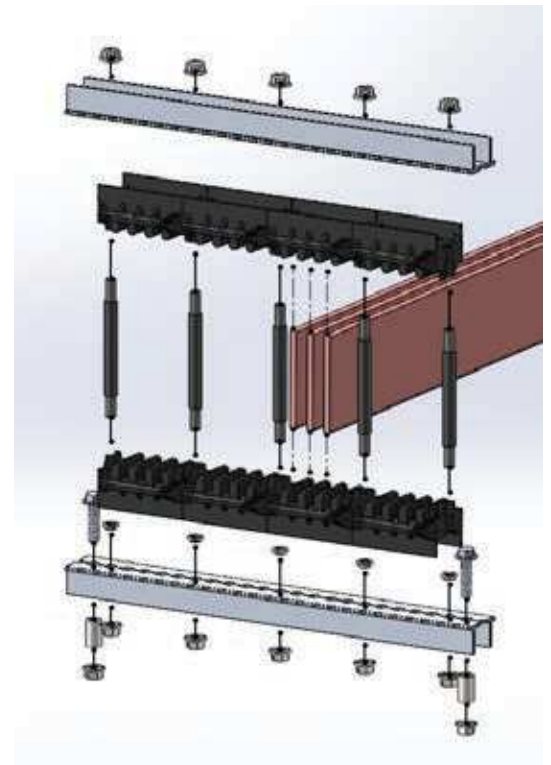

# Busbar Supports

## COMPACT ADJUSTABLE BUSBAR SUPPORTS, UL, IMPERIAL

### SIMPLE 4-STEP ORDERING PROCESS



#### 1 Select the CABS modules/insulator kit, in function of:

- Busbar thickness (1/4 or 3/8 inches)
- Number of phases (3 or 4 phases system)
- Number of bars per phases (2, 3 or 4)

Article Number	Description		lb
549500	CABS142T, ASM CABS 1/4-IN BUSBAR 2 SLOTS 3-PHASE	1	0.95 lb
549501	CABS143T, ASM CABS 1/4-IN BUSBAR 3 SLOTS 3-PHASE	1	1.54 lb
549502	CABS144T, ASM CABS 1/4-IN BUSBAR 4 SLOTS 3-PHASE	1	1.61 lb
549503	CABS382T, ASM CABS 3/8-IN BUSBAR 2 SLOTS 3-PHASE	1	1.23 lb
549504	CABS383T, ASM CABS 3/8-IN BUSBAR 3 SLOTS 3-PHASE	1	1.28 lb
549505	CABS384T, ASM CABS 3/8-IN BUSBAR 4 SLOTS 3-PHASE	1	1.90 lb
549506	CABS142TN, ASM CABS 1/4-IN BUSBAR 2 SLOTS 3-PHASE NEUTRAL	1	1.26 lb
549507	CABS143TN, ASM CABS 1/4-IN BUSBAR 3 SLOTS 3-PHASE NEUTRAL	1	2.05 lb
549508	CABS144TN, ASM CABS 1/4-IN BUSBAR 4 SLOTS 3-PHASE NEUTRAL	1	2.14 lb
549509	CABS382TN, ASM CABS 3/8-IN BUSBAR 2 SLOTS 3-PHASE NEUTRAL	1	1.63 lb
549510	CABS383TN, ASM CABS 3/8-IN BUSBAR 3 SLOTS 3-PHASE NEUTRAL	1	1.72 lb
549511	CABS384TN, ASM CABS 3/8-IN BUSBAR 4 SLOTS 3-PHASE NEUTRAL	1	2.54 lb

#### 3 Select Length of threaded rod, in function of :

- Busbar Width
- 3 or 4 phases system
- Single or Double profile configuration

Busbar Width in	Rod Length for single profile mm	Rod Length for double profile mm	Busbar Width in
2.0	140	140	2.0
2.5			2.5
3.0			3.0
4.0	190	190	4.0
5.0			5.0
6.0	220	220	6.0

Article Number	Description	lb
549526	CABS140HWT, ASM CABS HARDWARE 140 T	0.60 lb
549527	CABS190HWT, ASM CABS HARDWARE 190 T	0.66 lb
549528	CABS220HWT, ASM CABS HARDWARE 220 T	0.67 lb
549529	CABS140HWTN, ASM CABS HARDWARE 140 TN	0.75 lb
549530	CABS190HWTN, ASM CABS HARDWARE 190 TN	0.82 lb
549531	CABS220HWTN, ASM CABS HARDWARE 220 TN	0.91 lb



#### 2 Select Length Aluminum support rail, in function of :

- Span / deep of the enclosure
- Or installation method

Article Number	Description		lb
549512	CABSAL18, ASM CABS ALU SUPPORT 18IN	2	1.52 lb
549513	CABSAL24, ASM CABS ALU SUPPORT 24IN	2	2.03 lb
549514	CABSAL30, ASM CABS ALU SUPPORT 30IN	2	2.54 lb
549515	CABSAL36, ASM CABS ALU SUPPORT 36IN	2	3.04 lb
549516	CABSAL48, ASM CABS ALU SUPPORT 48IN	2	4.06 lb
549517	CABSAL54, ASM CABS ALU SUPPORT 54IN	2	4.56 lb

#### 4 (Optional) Select Bracket, in function of:

- Mounting configuration

Article Number	Description		lb
549518	CABSBRKTKITM, KIT CABS IMPERIAL BRKT M	10	1.32 lb
549519	CABSBRKTKITT, KIT CABS IMPERIAL BRKT T	10	0.25 lb
549520	CABSBRKTKITE, KIT CABS IMPERIAL BRKT E	10	0.27 lb
549532	CABSBRKTKITBVM6	10	0.26 lb

# Busbar Supports

## UNIVERSAL BUSBAR SUPPORTS (METRIC)

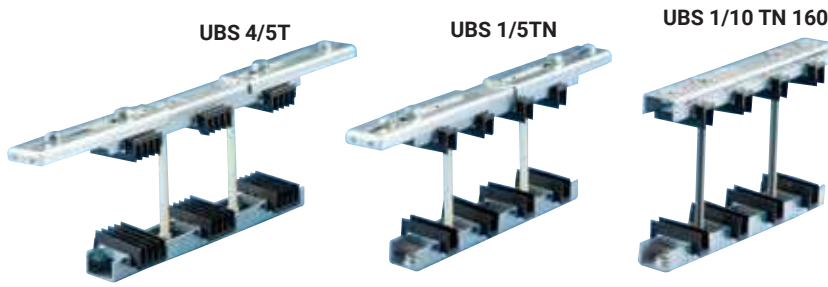

- Complete range of 15 supports
- Extremely robust construction
- Universal fixing system
- Time saving during mounting procedure
- Halogen free insulators
- Working temperature: -40°C up to 130°C
- Self extinguishing UL® 94 V0



Bureau VERITAS  
Certificate No. 419419 / DO BV for  
shipboard use

### TECHNICAL CHARACTERISTICS

- 1) 2.5 mm reinforced and formed zinc plated steel sheet
- 2) Insulators in polyamide, glass fiber reinforced, halogen free
- 3) Busbars fixed and tightened using reinforced polyamide M10 screws (in stainless steel for bars 160 and 200 mm)
- 4) Adjustable distance between fixing centers
- 5) Distance between lateral fixing centers: 25 mm
- 6) Provision for direct fixing of a screen using 2 M10 integrated flush nuts

### UBS 1/5TN

#### 1700A

- 3 phase + neutral circuit
- Busbar thickness: 5 mm
- Busbar width: 30 to 125 mm

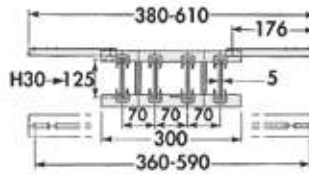

Article No.	Description	Number of Busbars per phase		kg
551000	UBS 1/5 TN	1	1	1.86

### UBS 1/10TN

#### 2250A

- 3 phase + neutral circuit
- Busbar thickness: 10 mm
- Busbar width: 30 to 120 mm

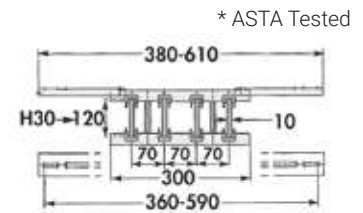

Article No.	Description	Number of Busbars per phase		kg
551060	UBS 1/10 TN*	1	1	1.86

### UBS 4/5T & 4/5TN

#### 3500A

- 3 phase (4/5 T)
- 3 phase + neutral circuit (4/5 TN)
- Busbar thickness: 5 mm
- Busbar width: 30 to 125 mm

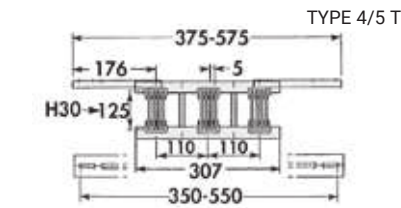
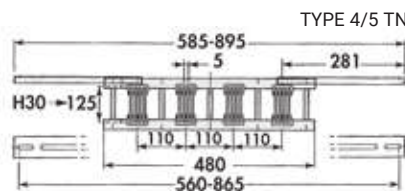

Article No.	Description	Number of Busbars per phase		kg
551010	UBS 4/5 TN	1-4	1	2.88
551020	UBS 4/5 T	1-4	1	2.22

### UBS 1/10TN 160 & 200

#### 3500A

- 3 phase + neutral circuit
- Busbar thickness: 10 mm
- Busbar width: 160 to 200 mm
- Assembling without extension arms

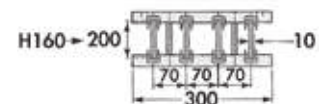

Article No.	Description	Number of Busbars per phase		kg
561500	UBS 1/10 TN 160	1	1	2.30

T = 3 phases  
TN = 3 phases + neutral

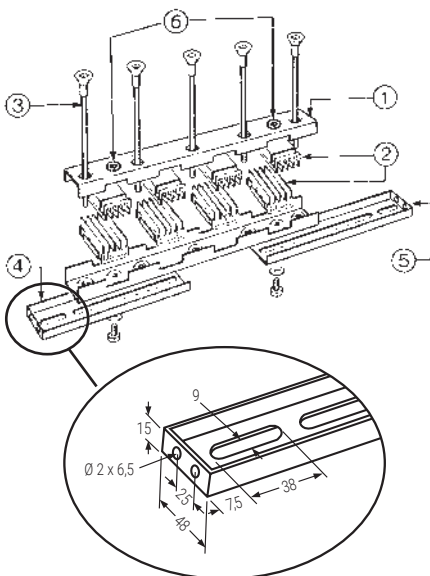

# Busbar Supports

## UNIVERSAL BUSBAR SUPPORTS (METRIC)

UBS 2/10TN 200



UBS 2/10TN



UBS 2/10T

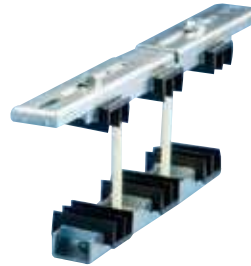

### UBS 2/10T

#### 3600A

- 3 phase
- Busbar thickness: 10 mm
- Busbar width: 30 to 120 mm

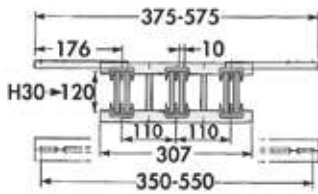

Article No.	Description	Number of Busbars per phase	Box	kg
551080	UBS 2/10 T	1-2	1	2.18

### UBS 2/10TN

#### 3600A

- 3 phase + neutral circuit
- Busbar thickness: 10 mm
- Busbar width: 30 to 120 mm

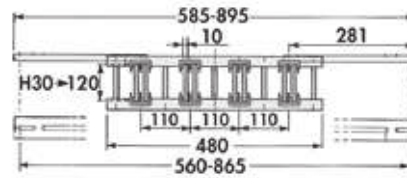

Article No.	Description	Number of Busbars per phase	Box	kg
551070	UBS 2/10 TN	1-2	1	2.86

### UBS 3/10TN

#### 4500A

- 3 phase + neutral
- Busbar thickness: 10 mm
- Busbar width: 30 to 120 mm

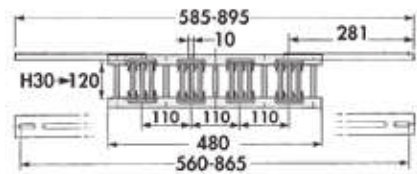

Article No.	Description	Number of Busbars per phase	Box	kg
551090	UBS 3/10 TN	1-3	1	2.90

### UBS 2/10T 160 & 200

#### 5700A

- 3 phase
- Busbar thickness: 10 mm
- Busbar width: 160 to 200 mm
- Assembling without extension arms

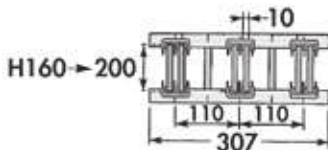

Article No.	Description	Number of Busbars per phase	Box	kg
561520	UBS 2/10 T 160	1-2	1	2.60

### UBS 2/10TN 160 & 200

#### 5700A

- 3 phase + neutral circuit
- Busbar thickness: 10 mm
- Busbar width: 160 to 200 mm
- Assembly without extension arms

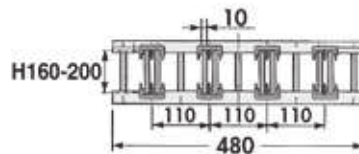

Article No.	Description	Number of Busbars per phase	Box	kg
561870	UBS 2/10 TN 160	1-2	1	3.40
561880	UBS 2/10 TN 200	1-2	1	3.50

### UBS 3/10TN 160 & 200

#### 7400A

- 3 phase + neutral circuit
- Busbar thickness: 10 mm
- Busbar width: 160 to 200 mm
- Assembling without extension arms

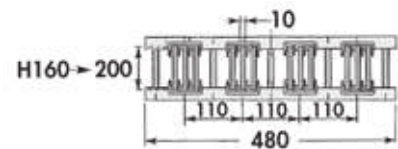

Article No.	Description	Number of Busbars per phase	Box	kg
561540	UBS 3/10 TN 160	1-3	1	3.40

# Busbar Supports

## ADJUSTABLE BUSBAR SUPPORT (METRIC)

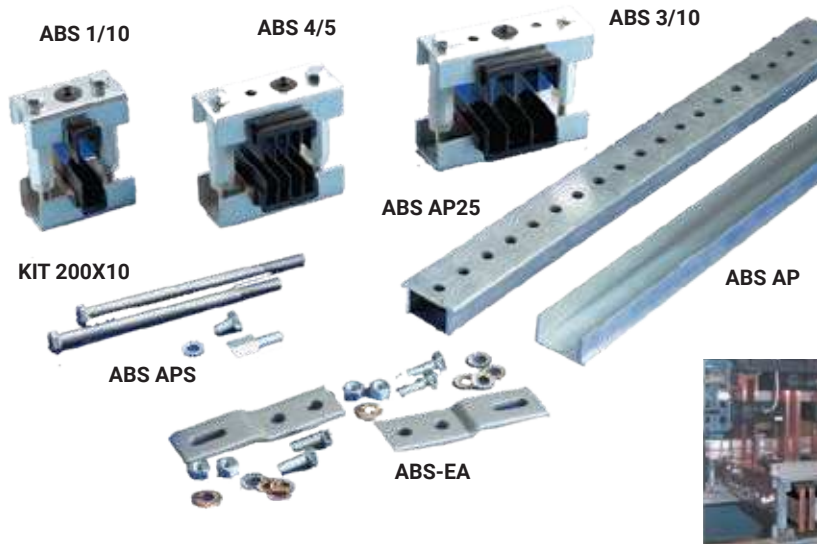

- Freedom to select the desired distance
- Extremely robust construction
- Universal fixing system
- Time saving due to rapid assembly process
- Working temperature: -40°C up to 130°C
- Halogen free
- Self extinguishing UL® 94 V0



### ABS

Offering Real Simplicity With Just 2 Components:

- 1 – Aluminum profiles 2 m
- 2 – Single kits enabling phase assembly

#### • Up To 7400 A

- Panels: 300 to 900 mm
- Bars: 50 to 200 mm
- Thickness: 5 or 10 mm
- Busbars IP 00/Erilink

#### Freedom With Which To Select:

- The desired distance between each phase
- The desired configuration: bipolar, tripolar, tetrapolar

#### 1 Aluminum Profiles 2M 2 different options:

- Punched 25 mm holes pitch
- Plain to be drilled

#### 2 Single Kits Enabling Phase Assembly 5 different modules:

- 1/5: 1 bar 50-125 x 5 mm per phase
- 4/5: 2,3,4 bars 50-125 x 5 mm per phase
- 1/10: 1 bar 50-120 x 10 mm per phase\*
- 2/10: 2 bars 50-120 x 10 mm per phase\*
- 3/10: 3 bars 50-120 x 10 mm per phase\*

Aluminum Profile Rigidity  
How to improve the Bending Resistance, according to your configuration:

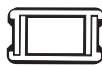

For calculation purpose:  
see nVent ERIFLEX Software

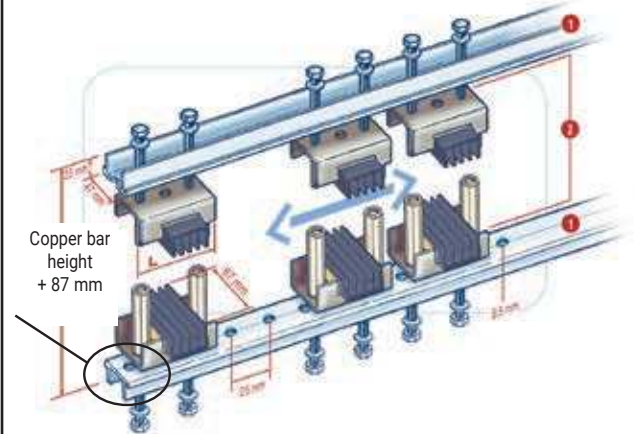

Article No.	Description	Designation			L
			kg		
560930	ABS AP25	ABS perfo alu profile 25	2	1.35	
560940	ABS AP	ABS alu profile	2	1.37	
560860	ABS 1/5	ABS module 1/5	1	0.64	74
560870	ABS 4/5	ABS module 4/5	1	0.73	99
560880	ABS 1/10	ABS module 1/10	1	0.64	74
560890	ABS 2/10	ABS module 2/10	1	0.73	99
560900	ABS 3/10	ABS module 3/10	1	0.81	124
560910	ABS 160 x 10	ABS kit 160 x 10	1	0.12	
560920	ABS 200 x 10	ABS kit 200 x 10	1	0.16	
560950	ABS APS	ABS profile stiffener kit	1	0.045	
560960	ABS-EA	ABS Erilink adaptor	1	0.170	

### Accessories

\*In Addition To The Above Modules

- Kit 160 x 10 (for 160 x 10 copper bar)
- Kit 200 x 10 (for 200 x 10 copper bar)

In Addition To The Above Aluminum Profiles:

- Profile stiffener kit (ABS APS)
- Combined profile reinforced
- Aluminum profile fixing with panel

# Spacers and Accessories

- A complete range of accessories for easy distribution block assembly

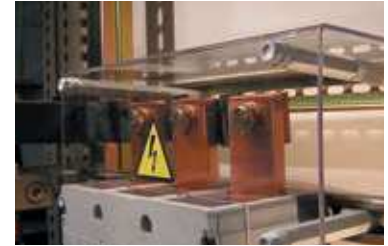
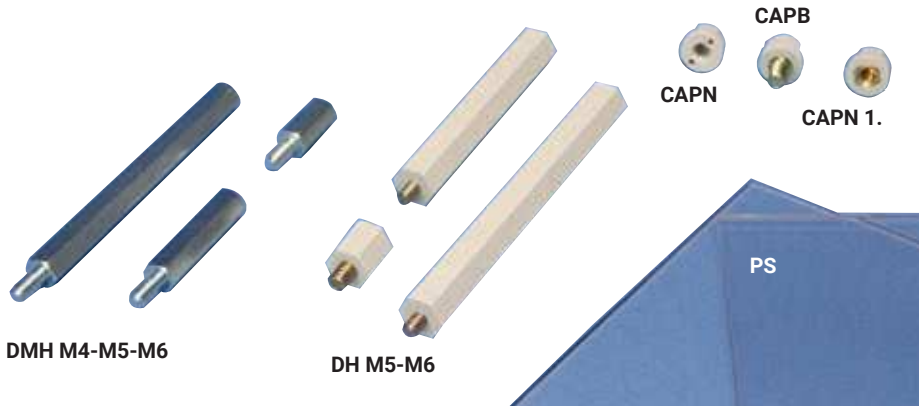

## DMH M4-M5-M6

### Metallic spacers

- Metallic hexagonal spacers
- Zinc plated steel
- To make higher plates, screens or profiles
- Male-female allowing stable mounting
- See drawing on DH

Article No.	Description	L mm	Ø mm	A mm	B mm		
561560	DMH10M4	10	M4	8-10	7	100	0.003
561570	DMH15M4	15	M4	8-10	7	100	0.005
561580	DMH20M4	20	M4	8-10	7	100	0.007
561590	DMH25M4	25	M4	8-10	7	50	0.008
561600	DMH30M4	30	M4	8-10	7	50	0.010
561610	DMH35M4	35	M4	8-10	7	50	0.012
561620	DMH40M4	40	M4	8-10	7	50	0.0125
561630	DMH50M4	50	M4	8-10	7	50	0.017
561640	DMH60M4	60	M4	8-10	7	25	0.019

561660	DMH15M5	15	M5	10	8	50	0.006
561670	DMH20M5	20	M5	10	8	50	0.008
561680	DMH25M5	25	M5	10	8	50	0.010
561690	DMH30M5	30	M5	10	8	50	0.012
561700	DMH35M5	35	M5	10	8	25	0.014
561710	DMH40M5	40	M5	10	8	25	0.016
561720	DMH50M5	50	M5	10	8	25	0.022
561730	DMH60M5	60	M5	10	8	25	0.027
561740	DMH70M5	70	M5	10	8	25	0.029
561750	DMH80M5	80	M5	10	8	25	0.033

561760	DMH15M6	15	M6	10	10	50	0.010
561770	DMH20M6	20	M6	12	10	50	0.012
561780	DMH30M6	30	M6	12	10	25	0.018
561790	DMH40M6	40	M6	12	10	25	0.025
561800	DMH50M6	50	M6	12	10	25	0.032
561810	DMH60M6	60	M6	12	10	25	0.038
561820	DMH70M6	70	M6	12	10	25	0.043
561830	DMH80M6	80	M6	12	10	25	0.052
561840	DMH90M6	90	M6	12	10	25	0.058
561850	DMH100M6	100	M6	12	10	10	0.064

## DH M5-M6

### Spacers

- Male-female
- Electrotechnical applications
- Insulating part made from polystyrol
- Threaded-end, made from zinc-plated steel
- Working temperature up to 80°C
- Insulation voltage 1000 V

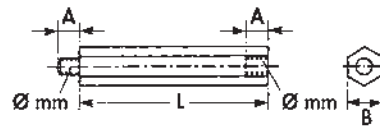

Article No.	Description	L mm	Ø mm	A mm	B mm		
560660	DH15M5	15	M5	7	13	100	0.004
560670	DH20M5	20	M5	7	13	100	0.005
560600	DH30M5	30	M5	7	13	100	0.006
560610	DH45M5	45	M5	7	13	100	0.009
560620	DH55M5	55	M5	7	13	100	0.011
560630	DH70M5	70	M5	7	13	100	0.014
560640	DH85M5	85	M5	7	13	100	0.017
560650	DH120M5	120	M5	7	13	100	0.024

560740	DH15M6	15	M6	7-8	13	100	0.004
560750	DH20M6	20	M6	7-8	13	100	0.005
560700	DH30M6	30	M6	7-8	13	100	0.009
560710	DH45M6	45	M6	7-8	13	100	0.013
560720	DH70M6	70	M6	7-8	13	100	0.020
560730	DH120M6	120	M6	7-8	13	100	0.035

## CAPN-CAPB

### Cap nuts

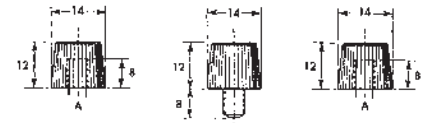

CAPN5 & CAPN6

CAPB5 & CAPB6

CAPN15 & CAPN16

with brass insert

Article No.	Description	A		
560800	CAPN5	M5	100	0.001
560810	CAPN6	M6	100	0.001
560820	CAPN15	M5	100	0.003
560830	CAPN16	M6	100	0.003
560840	CAPB5	M5	100	0.004
560850	CAPB6	M6	100	0.004

## PS

### Protection screen (made from PVC)

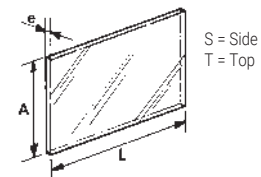

S = Side  
T = Top

Article No.	Description	L mm	A mm	e mm	Mounts to		
551330	PS500x126x3	500	126	3	BS125A/T	10	0.224
551260	PS1000x250x3	1000	250	3	BS400/T	1	1.030
551280	PS1000x2000x3	1000	2000	3	-	1	8.4

# Insulators



nVent offers a full range of nVent ERIFLEX low-voltage stand-off insulators from 1 inch to 3.5 inches with a total of 29 sizes available. The cost-effective insulators offer great stability of electrical and mechanical parameters and very high resistance to leakage current.

The insulators are manufactured from a halogen-free fiberglass-reinforced thermalset unsaturated polyester molded compound (BMC). Their electro-plated zinc inserts are threaded to ASME® standards. The insulators work in temperatures from -40°F to 266°F.

- Wide range of sizes from 1 inch to 3.5 inches
- Cost effective
- cULus Recognized for the US (ANSI/UL 891) and Canada (CAN/CSA C22.2 No 244) in File E125470
- Working range of -40°F to 266°F
- High resistance to leakage current
- Most sizes are rated as suitable for use with UL 891 Annex G based on tensile and cantilever strength tests
- Evaluated by UL for dielectric Voltage Withstand at 1500V AC/DC
- Insulator material has an ANSI/UL 94 flammability classification of V-0 and RTI rating of 266°F

The stand-off insulators meet the requirements of UL® 94 VO for self-extinguishing materials and are UL Recognized to Standard 891, Annex G, Dead-front Switchboards and Accessories, File No. E125470. The insulators are also UL recognized for Canada for material and strength. nVent ERIFLEX insulators are the first on the market to be in compliance with the CSA® standard.

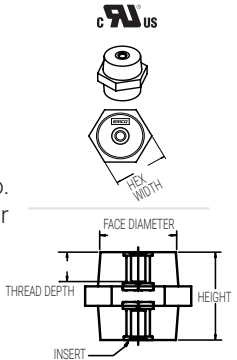

Description	Article No.	Article Height	Hex Width	Thread Dia	Thread Depth	Face Dia	Voltage AC/DC**	Max Working Load (lbs)*		Qty/box	Weight ea. lbs
								Tensile	Cantilever		
ISO 1", 1/4-20*	559600	1	1-1/8	1/4	5/16	0.82	1500	1500	350	50	0.057
ISO 1", 5/16-18*	559610	1	1-1/8	5/16	5/16	0.82	1500	1500	350	50	0.059
ISO 1-1/4", 1/4-20	559620	1-1/4	1-5/8	1/4	5/16	1.41	1500	2300	675	25	0.118
ISO 1-1/4", 3/8-16	559640	1-1/4	1-5/8	3/8	3/8	1.41	1500	2300	675	25	0.141
ISO 1-3/8", 3/8-16	559650	1-3/8	1-3/4	3/8	3/8	1.43	1500	2300	1200	25	0.208
ISO 1-1/2", 3/8-16	559660	1-1/2	2	3/8	3/8	1.68	1500	2300	1200	25	0.347
ISO 1-1/2", 1/4-20	559662	1-1/2	2	1/4	1/2	1.68	1500	2300	1200	25	0.273
ISO 1-1/2", 5/16-18	559663	1-1/2	2	5/16	1/2	1.68	1500	2300	1200	25	0.276
ISO 1-3/4", 3/8-16	559670	1-3/4	2	3/8	9/16	1.66	2000	3000	1200	25	0.382
ISO 1-3/4", 5/16-18	559671	1-3/4	2	5/16	1/2	1.66	2000	3000	1200	25	0.311
ISO 2", 1/2-13	559681	2	2	1/2	5/8	1.65	2300	3000	1200	25	0.426
ISO 2", 3/8-16	559680	2	2	3/8	9/16	1.65	2300	3000	1200	25	0.419
ISO 2", 5/16-18	559682	2	2	5/16	1/2	1.65	2300	3000	1200	25	0.354
ISO 2-1/8", 3/8-16	559683	2-1/8	2-1/2	3/8	5/8	2.14	2500	3000	1300	25	0.629
ISO 2-1/8", 1/2-13	559684	2-1/8	2-1/2	1/2	5/8	2.14	2500	3000	1300	25	0.655
ISO 2-1/8", 5/8-11	559685	2-1/8	2-1/2	5/8	5/8	2.14	2500	3000	1300	25	0.745
ISO 2-1/4", 1/2-13	559686	2-1/4	2-1/2	1/2	5/8	2.13	2700	4000	1400	25	0.687
ISO 2-1/4", 3/8-16	559687	2-1/4	2-1/2	3/8	5/8	2.13	2700	4000	1400	25	0.657
ISO 2-1/2", 1/2-13	559688	2-1/2	2-1/2	1/2	5/8	2.11	3200	4000	1400	10	0.743
ISO 2-1/2", 3/8-16	559689	2-1/2	2-1/2	3/8	5/8	2.11	3200	4000	1400	10	0.714
ISO 2-5/8", 5/8-11	559690	2-5/8	2-1/2	5/8	3/4	2.11	3400	4000	1400	10	0.858
ISO 2-3/4", 1/2-13	559691	2-3/4	2-1/2	1/2	5/8	2.10	3600	4000	1400	10	0.799
ISO 2-3/4", 3/8-16	559692	2-3/4	2-1/2	3/8	5/8	2.10	3600	4000	1400	10	0.770
ISO 3", 1/2-13	559693	3	2-1/2	1/2	5/8	2.08	4100	4000	1400	10	0.853
ISO 3", 3/8-16	559694	3	2-1/2	3/8	5/8	2.08	4100	4000	1400	10	0.824
ISO 3-1/4", 1/2-13	559695	3-1/4	2-1/2	1/2	5/8	2.06	4500	4000	1400	10	0.907
ISO 3-1/4", 3/8-16	559696	3-1/4	2-1/2	3/8	5/8	2.06	4500	4000	1400	10	0.878
ISO 3-1/2", 5/8-11	559697	3-1/2	2-1/2	5/8	3/4	2.05	5000	5000	1400	10	1.047
ISO 3-1/2", 3/8-16	559698	3-1/2	2-1/2	3/8	3/4	2.05	5000	5000	1400	10	0.950

\* Not recognized for strength

\*\* Creepage and clearance distances need to be in accordance with the relevant application standard

## ISOBOLT

### INSULATOR MOUNTING KITS

- Complete with stud, washer, lock washer, nut
- ISO M sizes
- Zinc plated steel



Article No.	Description	Thread	Length mm	Qty/box	Weight ea. lbs
552200	ISOBOLT 25 M6	M6	25	20	0.008
552220	ISOBOLT 30 M8	M8	30	20	0.017

# Insulators

## ISO-TP LOW VOLTAGE METRIC INSULATORS



- Working temperature -40°C up to 130°C
- Polyamide material reinforced with glass fiber
- Halogen free
- Zinc plated steel inserts, threaded to ISO standard
- Great stability of electrical and mechanical parameters
- Self-extinguishing: UL® 94 VO
- Creepage and clearance distances must be evaluated for end product requirements

- CE Conformity
- RoHS 2002/95/EC Compliance
- IEC compliance
- UL Recognized in E125470 and evaluated for dielectric withstand rating of 1500 Vac/Vdc
- EAC

Article No.	Description	Dimensional characteristics						Nominal Voltage		Mechanical		kg	
		H mm	Ch mm	ØF mm	h1 mm	ØD mm	P mm	Alternating V	Direct V	Tensile strength ▲ daN	Bending strength ► daN		
548400	ISO TP 15M4	15	14	M4 X 0.7	4	12	16	500	500	150	100	50	0.005
548410	ISO TP 20M4	20	17	M4 X 0.7	4	15	20	1000	1500	150	100	50	0.008
548420	ISO TP 20M6	20	17	M6 X 1	6	15	20	1000	1500	150	100	50	0.012
548700	ISO TP 25M5	25	19	M5 X 0.8	6	18	20	1000	1500	300	160	50	0.016
548430	ISO TP 25M6	25	19	M6 X 1	6	18	20	1000	1500	300	160	50	0.016
548440	ISO TP 30M6	30	30	M6 X 1	8	26	34	1000	1500	600	300	25	0.034
548450	ISO TP 30M8	30	30	M8 X 1.25	8	26	34	1000	1500	600	300	25	0.046
548451	ISO TP 30M10	30	30	M10 X 1.5	10	26	34	1000	1500	600	300	25	0.046
548470	ISO TP 35M6L	35	41	M6 X 1	8	34	46	1000	1500	1100	500	25	0.062
548480	ISO TP 35M8	35	41	M8 X 1.25	8	34	46	1000	1500	1100	800	25	0.074
548490	ISO TP 35M10	35	41	M10 X 1.5	10	34	46	1000	1500	1100	800	25	0.092
548500	ISO TP 40M6	40	46	M6 X 1	9	40	53	1000	1500	1100	800	25	0.098
548510	ISO TP 40M8	40	46	M8 X 1.25	8	40	53	1000	1500	1100	800	25	0.104
548520	ISO TP 40M10	40	46	M10 X 1.5	10	40	53	1000	1500	1100	450	25	0.102
548511	ISO TP 40M12	40	46	M12 X 1.75	14,5	40	53	1000	1500	1100	450	25	0.102
548530	ISO TP 45M6	45	41	M6 X 1	9	34	47	1000	1500	1100	650	25	0.104
548540	ISO TP 45M8	45	41	M8 X 1.25	15	34	47	1000	1500	1100	650	25	0.136
548550	ISO TP 45M8L	45	50	M8 X 1.25	15	41	57	1000	1500	1800	1000	25	0.132
548560	ISO TP 45M10	45	50	M10 X 1.5	10	41	57	1000	1500	1800	700	25	0.116
548570	ISO TP 50M6	50	50	M6 X 1	9	41	57	1000	1500	2000	700	25	0.152
548580	ISO TP 50M8	50	50	M8 X 1.25	15	41	57	1000	1500	2000	1000	25	0.148
548590	ISO TP 50M10	50	50	M10 X 1.5	10	41	57	1000	1500	2000	1000	25	0.196
548581	ISO TP 50M12	50	50	M12 X 1.75	14,5	41	57	1000	1500	2000	1000	25	0.190
548600	ISO TP 60M8	60	55	M8 X 1.25	15	44	63	1000	1500	2200	1000	25	0.192
548610	ISO TP 60M10	60	55	M10 X 1.5	10	44	63	1000	1500	2200	1000	25	0.380
548601	ISO TP 60M12	60	55	M12 X 1.75	14,5	44	63	1000	1500	2200	1000	25	0.360
548602	ISO TP 60M16	60	55	M16 X 2	20	44	63	1000	1500	2200	1000	25	0.350
548609	ISO TP 70M10	70	65	M10 X 1.5	10	52	75	1000	1500	2200	1000	10	0.480
548620	ISO TP 70M12	70	65	M12 X 1.75	20	52	75	1000	1500	2500	1600	10	0.470
548630	ISO TP 70M16	70	65	M16 X 2	20	52	75	1000	1500	2500	1600	10	0.374
548629	ISO TP 75M10	75	65	M10 X 1.5	10	51	75	1000	1500	2200	1000	10	0.530
548640	ISO TP 75M12	75	65	M12 X 1.75	20	51	75	1000	1500	3000	1600	10	0.470
548650	ISO TP 75M16	75	65	M16 X 2	20	51	75	1000	1500	3000	1600	10	0.382
548660	ISO TP 80M12	80	65	M12 X 1.75	20	52	75	1000	1500	3000	1600	10	0.510
548670	ISO TP 80M16	80	65	M16 X 2	20	52	75	1000	1500	3000	1600	10	0.404
548680	ISO TP 100M12	100	65	M12 X 1.75	14	46	75	1000	1500	3000	1000	10	0.476
548690	ISO TP 100M16	100	65	M16 X 2	20	46	20	1000	1500	3000	1500	10	0.508

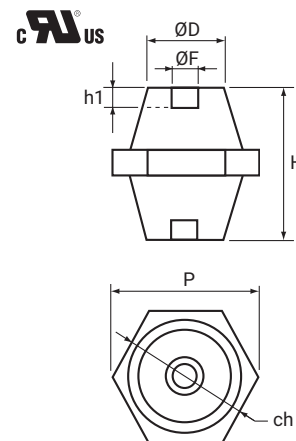

## LOW VOLTAGE METRIC MALE/FEMALE INSULATORS

Article No.	Description	Dimensional characteristics							Nominal Voltage		Mechanical		kg		
		H mm	Ch mm	ØF1 mm	H1 mm	ØD2 mm	H2 mm	ØD mm	P mm	Alternating V	Direct V	Tensile strength ▲ daN		Bending strength ► daN	
542030	ISO TP 30 MM8X17/FM8X8	30	30	M 8 X 1.25	8	M 8 X 1.25	17	26	34	1000	1500	600	300	25	0.05
542050	ISO TP 40 MM8X17/FM8X8	40	46	M 8 X 1.25	8	M 8 X 1.25	17	40	53	1000	1500	1100	650	25	0.11
542070	ISO TP 50 MM8X17/FM8X15	50	50	M 8 X 1.25	15	M 8 X 1.25	17	41	57	1000	1500	2000	1000	25	0.15
542080	ISO TP 60 MM8X17/FM8X15	60	55	M 8 X 1.25	15	M 8 X 1.25	17	44	63	1000	1500	2200	1000	25	0.19
542110	ISO TP 80 MM8X17/FM8X15	80	65	M 8 X 1.25	15	M 8 X 1.25	17	52	75	1000	1500	2200	1000	10	0.35
542120	ISO TP 100 MM12X25/FM12X20	100	65	M12 X 1.75	20	M12 X 1.75	20	46	75	1000	1500	3000	1000	10	0.51

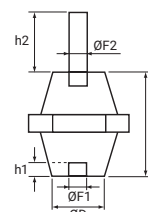

# Sleeves

## CABLING SLEEVES (METRIC)

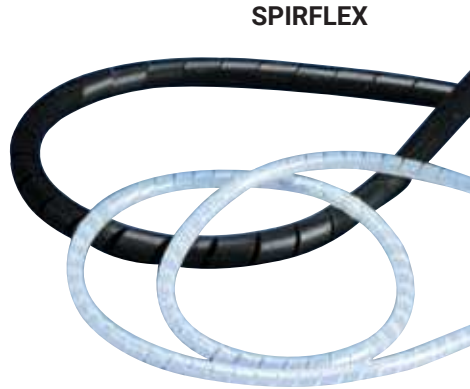

- Expandable cabling sleeves for many applications
- Wiring mechanical protection aesthetic
- Packed in easy dispense boxes



### PDBS

#### Polyamide 6/6 Braided Sleeves

- Highly expandable
- Provide complete wire coverage up to Ø 80 mm
- Halogen free
- Compact range: 10 parts only
- 2 colors: grey or black

	Polyamide
Density (Kg/dm <sup>3</sup> )	1,14
Min. working T°	- 40°C
Max. working T°	+ 120°C
Max. T° 1s	240°C
Self-extinguishing	UL 94 V2



### NVENT ERIFLEX SPIRFLEX

#### Spiriflex Spiral Sleeves

- Expandable cabling sleeves for many applications
- Spiral structure allow cables to branch out at any point
- Flexible bundling and mechanical protection of electrical cables and wires
- Packed in easy dispense boxes
- Halogen free
- Working Temperature: -50 to 85 °C
- Flammability Rating: UL® 94V-0

Article No.	Description Grey	Article No.	Description Black	Diameter (mm)						kg	
				Nom.	Covering %	Min.	Covering %	Max.	Covering %		
554430	PDBS 5G	554730	PDBS 5B	5	97%	4	100%	8	90%	100	0.004
554450	PDBS 8G	554750	PDBS 8B	8	94%	6	100%	10	91%	100	0.006
554460	PDBS 10G	554760	PDBS 10B	10	95%	8	100%	14	94%	100	0.008
554470	PDBS 12G	554770	PDBS 12B	12	96%	10	100%	16	94%	50	0.010
554490	PDBS 16G	554790	PDBS 16B	16	96%	14	100%	18	98%	50	0.013
554510	PDBS 20G	554810	PDBS 20B	20	95%	16	100%	25	99%	50	0.018
554530	PDBS 30G	554830	PDBS 30B	30	90%	20	100%	35	92%	50	0.027
554550	PDBS 40G	554850	PDBS 40B	40	90%	30	100%	45	94%	50	0.036

Article No.	Description	Internal dia. mm	Color	kg	kg
556000	Spiriflex I 6	6	black	50 m	0.017
556010	Spiriflex I 12	12	black	25 m	0.042
556020	Spiriflex I 16	16	black	25 m	0.11
556030	Spiriflex I 22	22	black	25 m	0.12
556100	Spiriflex X 6	6	white	50 m	0.017
556110	Spiriflex X 12	12	white	25 m	0.042

#### \* On Request:

- Polyester Sleeves
- Rilsan Sleeves
- Other Material On Study

Products on this page are world wide and are not UL® Recognized

# Sleeves

## CABLING SLEEVES (METRIC)

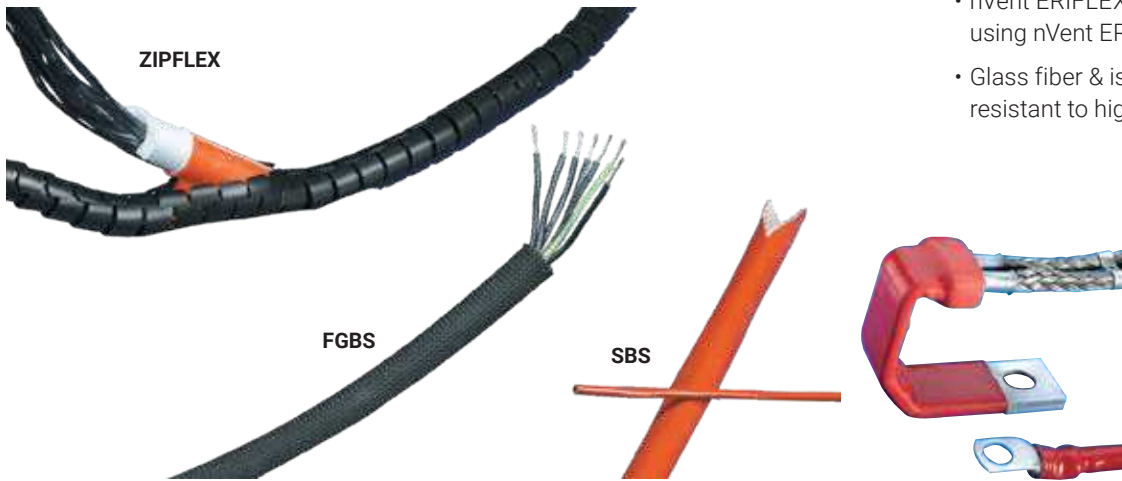

- nVent ERIFLEX Zipflex: Easy screening using nVent ERIFLEX specific tool
- Glass fiber & isolating silicone sleeves: resistant to high temperature

### ZIPFLEX

#### Zipflex Sleeves

- Polypropylene
- Easy and quick screening
- Practical tool included in every box
- Color: black
- Usage maxi: T° 140°C
- Usage mini: T° -30°C
- Continue: T° -30 till + 110°C
- Halogen free
- UL® 94 HB



Article No.	Description	Internal dia. mm			kg
554880	Zipflex 8	8	100 m		0.015
554890	Zipflex 15	15	50 m		0.044
554900	Zipflex 20	20	30 m		0.070
554910	Zipflex 25	25	20 m		0.100

### FGBS

#### Glass Fiber Braided Sleeves

- Glass fiber impregnated with high temperature varnish
- Thermal insulation and mechanical protection
- Working temperature: -70°C up to 400°C
- Halogen free
- Flammability UL 1441 VW1
- Expandable on a 1 to 3 ratio basis

Article No.	Description	Nominal dia. mm	Max expanded dia. mm			kg
556200	FGBS 4	4	12	100 m		0.010
556210	FGBS 8	8	24	100 m		0.014
556220	FGBS 10	10	30	100 m		0.016
556230	FGBS 12	12	36	100 m		0.018
556240	FGBS 15	15	45	50 m		0.030
556250	FGBS 20	20	60	50 m		0.044

### SBS



#### Isolating Silicone Sleeves

- Glass fiber coated with silicone
- Cost effective sleeve for insulation
- High flexibility
- Dielectric voltage: 2.5 Kv
- Working temperature: -60° up to 220°C
- Halogen free
- Flammability UL 1441 VW1
- Max Working Voltage, IEC and UL: 690 VAC/DC

Article No.	Description	Internal dia. mm			kg
554000	SBS 4	4	100 m		0.020
554010	SBS 6	6	100 m		0.038
554020	SBS 8	8	100 m		0.050
554030	SBS 10	10	100 m		0.054
554040	SBS 12	12	100 m		0.070
554050	SBS 15	15	25 m		0.111
554060	SBS 20	20	25 m		0.148
554070	SBS 25	25	30 m		0.185
554080	SBS 30	30	30 m		0.222

# Profiles / DIN Rail

## STEEL PROFILES

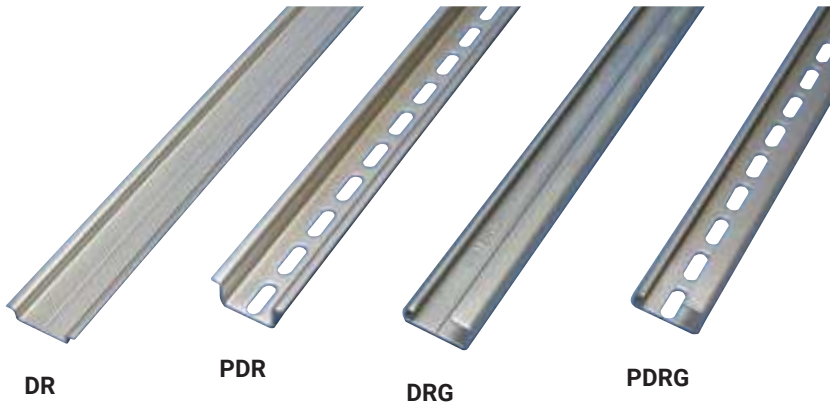

- Galvanized steel construction
- High mechanical resistance and high corrosion resistance
- Conforms to EN 50035 and 50022 and DIN 46277
- Available in symmetric, asymmetric profiles both perforated and solid

### DR

#### Symmetric Profiles

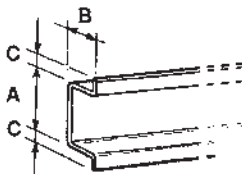

Article No.	Description	Thickness mm	A in	B in	C in	Lg in		
557700	DR 5.5 2 m	10/10	0.39	0.2	0.08	78.74	15	1.61
557800	DR 7 2 m	10/10	1.06	0.27	0.15	78.74	15	3.2
557900	DR 15 2 m	15/10	1.06	0.59	0.15	78.74	15	6.32

### PDR

#### Perforated Symmetric Profiles

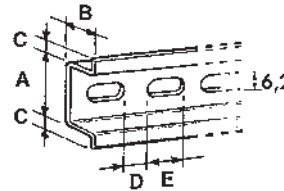

Article No.	Description	Thickness mm	A in	B in	C in	D in	E in	Lg in		
557750	PDR 5.5 2M	10/10	0.39	0.20	0.08	0.27	0.47	78.74	15	1.37
557850	PDR 7 2M	10/10	1.06	0.27	0.15	0.27	0.71	78.74	15	3.02
557855	PDR 7 2M*	10/10	1.06	0.27	0.15	0.43	0.98	78.74	15	3.02
557950	PDR 15 2M	15/10	1.06	0.59	0.15	0.27	0.71	78.74	15	5.84

### DRG

#### Asymmetric Profiles

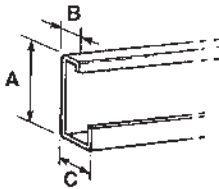

Article No.	Description	Thickness mm	A in	B in	C in	Lg in		
558000	DRG 2M	15/10	1.26	0.35	0.59	78.74	15	1.40

### PDRG

#### Perforated Asymmetric Profiles

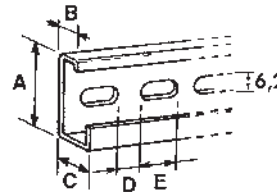

Article No.	Description	Thickness mm	A in	B in	C in	D in	D in	Lg in		
558050	PDRG 2M	15/10	1.26	0.35	0.59	0.27	0.71	78.74	15	6.7

### MDRCPT-2



MDRCPT-2

#### MANUAL DIN RAIL CUTTING AND PUNCHING TOOL

- Punches slots and cuts DIN rail without burrs or deformation
- Punches horizontal and vertical slots
- Works with five different types of DIN rail and M6 threaded rod
- Includes ruler, guide and end stops
- RoHS compliant

Overall Dimensions  
 Length: 100 mm - Depth: 165 mm  
 Height: 200 mm - Slot Size: 6.5 x 9.5 mm

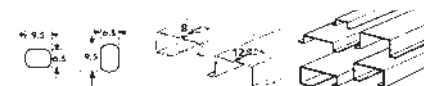

Article No.	Description		
559142	MDRCPT-2	1	28.66

# Cross Reference List

Article Number	Page	Article Number	Page	Article Number	Page
549220	6	550910	7	568630	14
550210	6	550920	7	556910	14
550220	6	550930	7	562100	14
550230	6	550940	7	553450	14
549000	6	550950	7	553490	14
549010	6	553020	8	568668	15
549020	6	553030	8	568667	15
549230	6	553040	8	568669	15
550200	6	553050	8	568670	15
549200	6	553060	8	568672	15
549210	6	553070	8	568671	15
550190	6	568700	8	568673	16
550250	6	568730	8	568674	16
549030	6	553200	8	568675	16
550290	6	553210	8	568676	16
550180	6	553220	8	568677	16
550160	6	553230	8	568678	17
550400	7	553250	8	568679	17
550410	7	553260	8	568680	17
550420	7	553100	8	568612	18
550430	7	553110	8	568613	18
550440	7	553120	8	568614	18
550450	7	553405	9	568710	19
550350	7	553400	9	568711	19
550360	7	553410	9	568712	19
550370	7	553510	9	568713	19
550380	7	553520	9	568714	19
550390	7	553505	9	568715	19
550780	7	553430	9	568716	20
550790	7	553440	9	568717	20
550770	7	553530	9	568718	20
549600	7	553540	9	568719	20
549610	7	553080	9	568720	20
549620	7	553090	9	568721	20
549630	7	561210	9	568722	20
549640	7	561220	9	551350	21
550600	7	553150	11	551190	21
550610	7	553152	12	562700	21
550620	7	553153	12	562710	21
550630	7	553151	12	562750	21
550640	7	568665	13	562760	21
550650	7	568666	13	562800	21
550660	7	568660	13	562810	21
550670	7	568661	13	562830	21
549700	7	568662	13	562840	21
549710	7	553460	14	504971	22
549720	7	553480	14	504980	22
549730	7	553470	14	504991	22
549740	7	563410	14	551151	23
549750	7	556640	14	551181	23
549760	7	556740	14	552050	23
550970	7	568610	14	552070	23
550980	7	568611	14	549310	25
550900	7	568620	14	549320	25

# Cross Reference List

Article Number	Page	Article Number	Page	Article Number	Page
549260	25	561540	30	560730	32
549270	25	560930	31	551330	32
549370	25	560940	31	551260	32
549380	25	560860	31	551280	32
549390	25	560870	31	560800	32
549340	25	560880	31	560810	32
549350	25	560890	31	560820	32
549360	25	560900	31	560830	32
549300	25	560910	31	560840	32
549450	25	560920	31	560850	32
549470	25	560950	31	559600	33
549480	25	560960	31	559610	33
549400	25	561560	32	559620	33
549410	25	561570	32	559640	33
549420	25	561580	32	559650	33
549430	25	561590	32	559660	33
549500	28	561600	32	559662	33
549501	28	561610	32	559663	33
549502	28	561620	32	559670	33
549503	28	561630	32	559671	33
549504	28	561640	32	559681	33
549505	28	561660	32	559680	33
549506	28	561670	32	559682	33
549507	28	561680	32	559683	33
549508	28	561690	32	559684	33
549509	28	561700	32	559685	33
549510	28	561710	32	559686	33
549511	28	561720	32	559687	33
549512	28	561730	32	559688	33
549513	28	561740	32	559689	33
549514	28	561750	32	559690	33
549515	28	561760	32	559691	33
549516	28	561770	32	559692	33
549517	28	561780	32	559693	33
549526	28	561790	32	559694	33
549527	28	561800	32	559695	33
549528	28	561810	32	559696	33
549529	28	561820	32	559697	33
549530	28	561830	32	559698	33
549531	28	561840	32	548400	34
549518	28	561850	32	548410	34
549519	28	560660	32	548420	34
549520	28	560670	32	548700	34
551000	29	560600	32	548430	34
551010	29	560610	32	548440	34
551020	29	560620	32	548450	34
551060	29	560630	32	548451	34
561500	29	560640	32	548470	34
551080	30	560650	32	548480	34
561520	30	560740	32	548490	34
551070	30	560750	32	548500	34
561870	30	560700	32	548510	34
561880	30	560710	32	548520	34
551090	30	560720	32	548511	34

# Cross Reference List

Article Number	Page
548530	34
548540	34
548550	34
548560	34
548570	34
548580	34
548590	34
548581	34
548600	34
548610	34
548601	34
548602	34
548609	34
548620	34
548630	34
548629	34
548640	34
548650	34
548660	34
548670	34
548680	34
548690	34
542030	34
542050	34
542070	34
542080	34
542110	34
542120	34
554430	35
554450	35
554460	35
554470	35
554490	35
554510	35
554530	35
554550	35
556000	35
556010	35
556020	35
556030	35
556100	35
556110	35
554880	36
554890	36
554900	36
554910	36
556200	36
556210	36
556220	36
556230	36
556240	36
556250	36
554000	36
554010	36

Article Number	Page
554020	36
554030	36
554040	36
554050	36
554060	36
554070	36
554080	36
557700	37
557800	37
557900	37
558000	37
557750	37
557850	37
557855	37
557950	37
558050	37
559142	37

## OTHER LITERATURE

**DISTRIBUTION  
BLOCKS,  
POWER  
BLOCKS AND  
DISTRIBUTION  
TERMINAL**

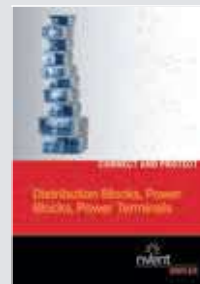

**HYDRAULIC  
& MANUAL  
TOOLS**



**FLEXIBLE  
CONDUCTORS**



**READY-TO-USE  
POWER  
CONDUCTOR:  
IBS & IBSB  
ADVANCED  
TECHNICAL  
GUIDE**



**NVENT  
ERIFLEX  
FLEXIBAR  
TECHNICAL  
HANDBOOK**

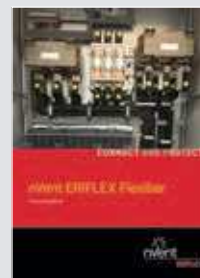



Our powerful portfolio of brands:

**CADDY ERICO HOFFMAN RAYCHEM SCHROFF TRACER**



[nVent.com/ERIFLEX](https://nVent.com/ERIFLEX)