



Quality Products. Service Excellence.

Lifting Eye Bolt *HDMELB Series*

Features



- Constructed of C1030/C1035 Carbon Steel.
- Ideal for lifting a cabinet into place.
- Mounts to the front rails and rests against the body of the cabinet or rack.
- ASTM B633 Zinc-plated finished, FE/Zn 5, Type III.
- 2,400 lbs (1,088.62 kg) load rating.
- RoHS Compliant.

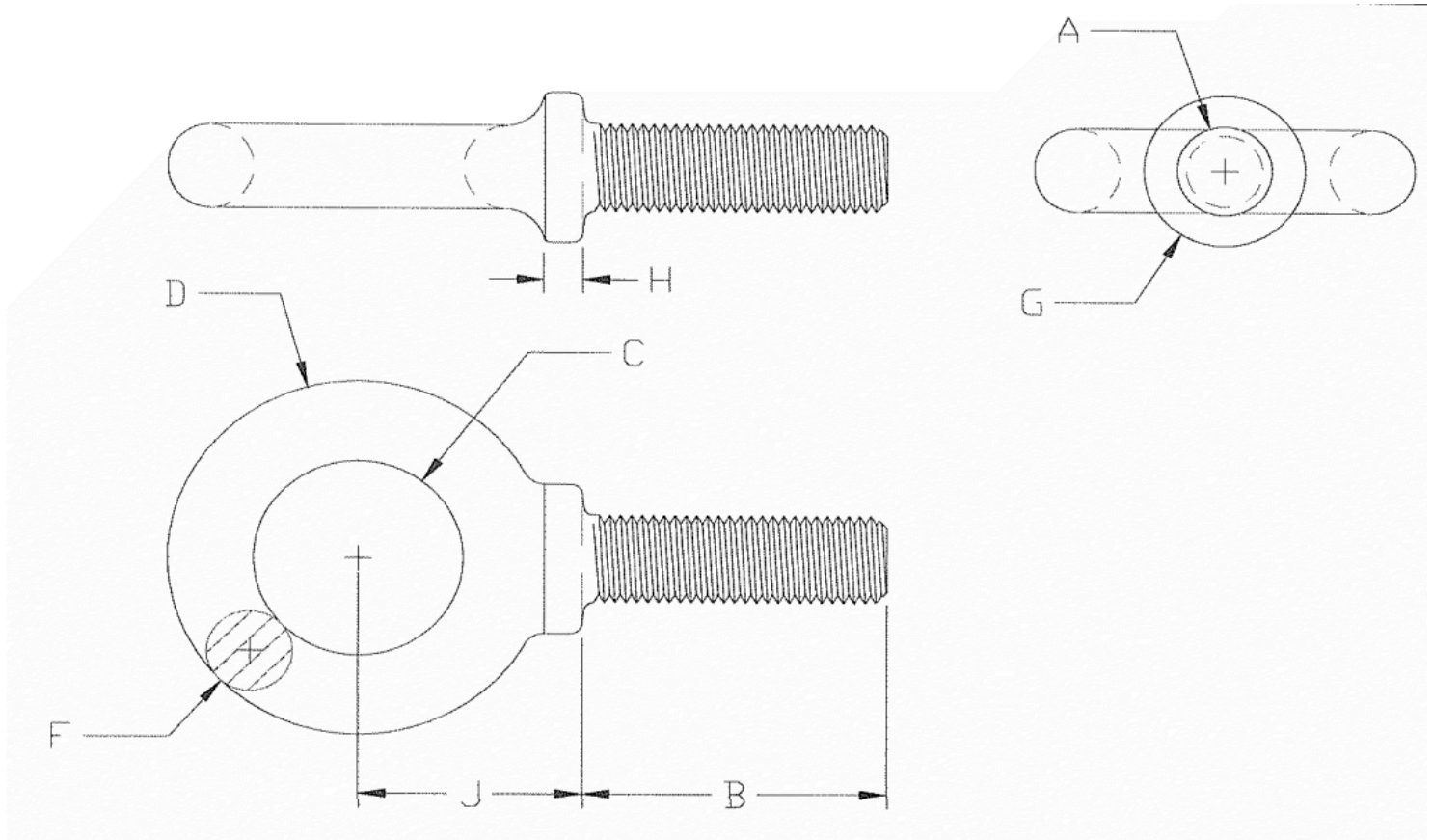

	A	B	C	D	F	G	H	J
	Thrd Dia-TPI	Shank	Eye	Eye O.D.	Eye	Collar	Collar	
Part No.	(UNC-2A*)	Length	I.D.	(Nominal)	Sect. Ø	Diameter	Thickness	Loaction
HDMELB	1/2-13	1.56	1.19	2.12	0.47	0.91	0.22	1.38

© 2025. Hammond Manufacturing Ltd. All rights reserved.