

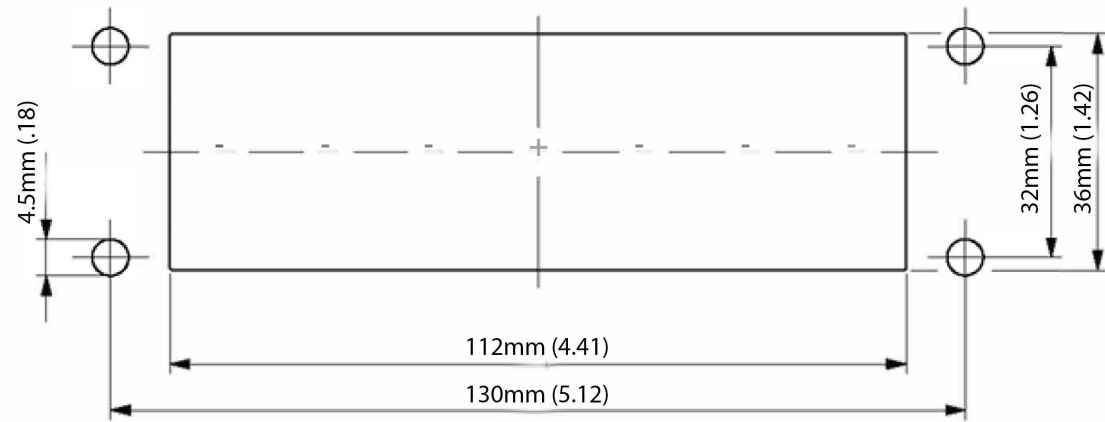

Cable Entry Systems  
Cable Entry Gland Plate Rectangular, CEPH  
(Screw-on mount from the inside.)

Screw-on mount from the inside.

PRODUCT DATA

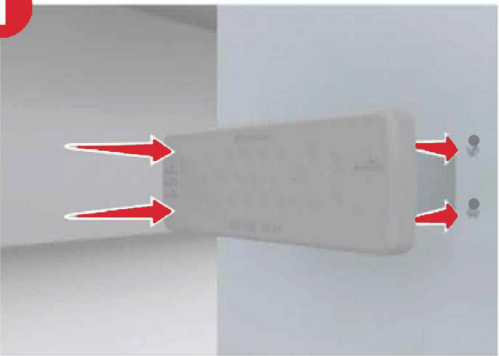
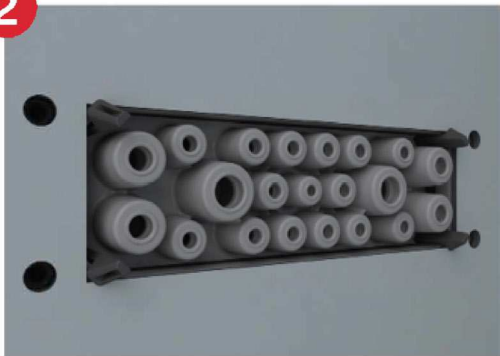
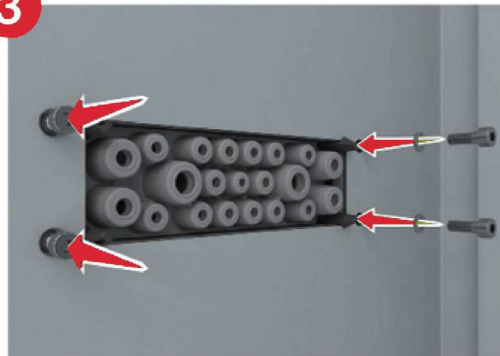
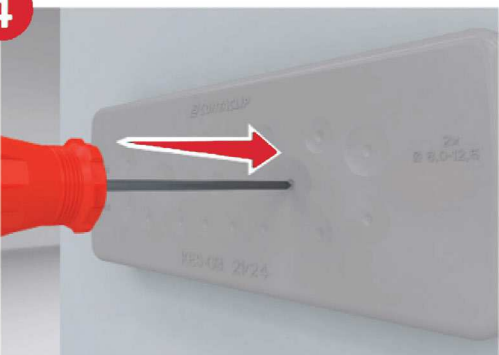
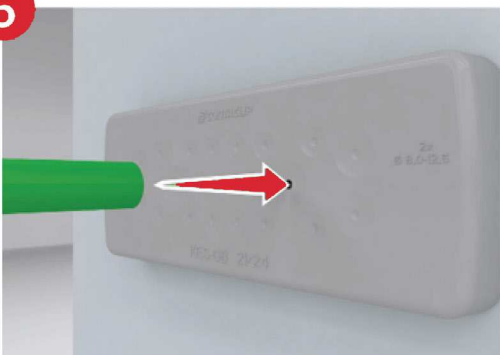
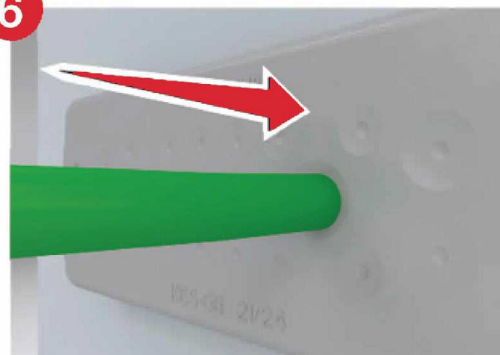

INSTALLATION

- 1 
- 2  Push through from outside until latching clips click in.
- 3  We recommend 4 M5 screws with length to account for 3mm thick gland plate, plus thickness of your enclosure. Torque to 3 NM (26 in-lbs)
- 4  Pierce the membrane at the push-through point.
- 5 
- 6  Push through to the inside.



According to UL Standard 508A, the following Conditions of Acceptability apply:

**NEMA Type 4/4X**

Only applies when the CEPH variant is secured with screws and the cables/wires have max. diameter of the pierced membrane holes.

**NEMA Type 1**

When the CEPH variant is secured with screws and fitted with smaller cables/wires.

**NEMA Type 1**

For all CEPH variants secured only by latching clips.