

PROLINE G2

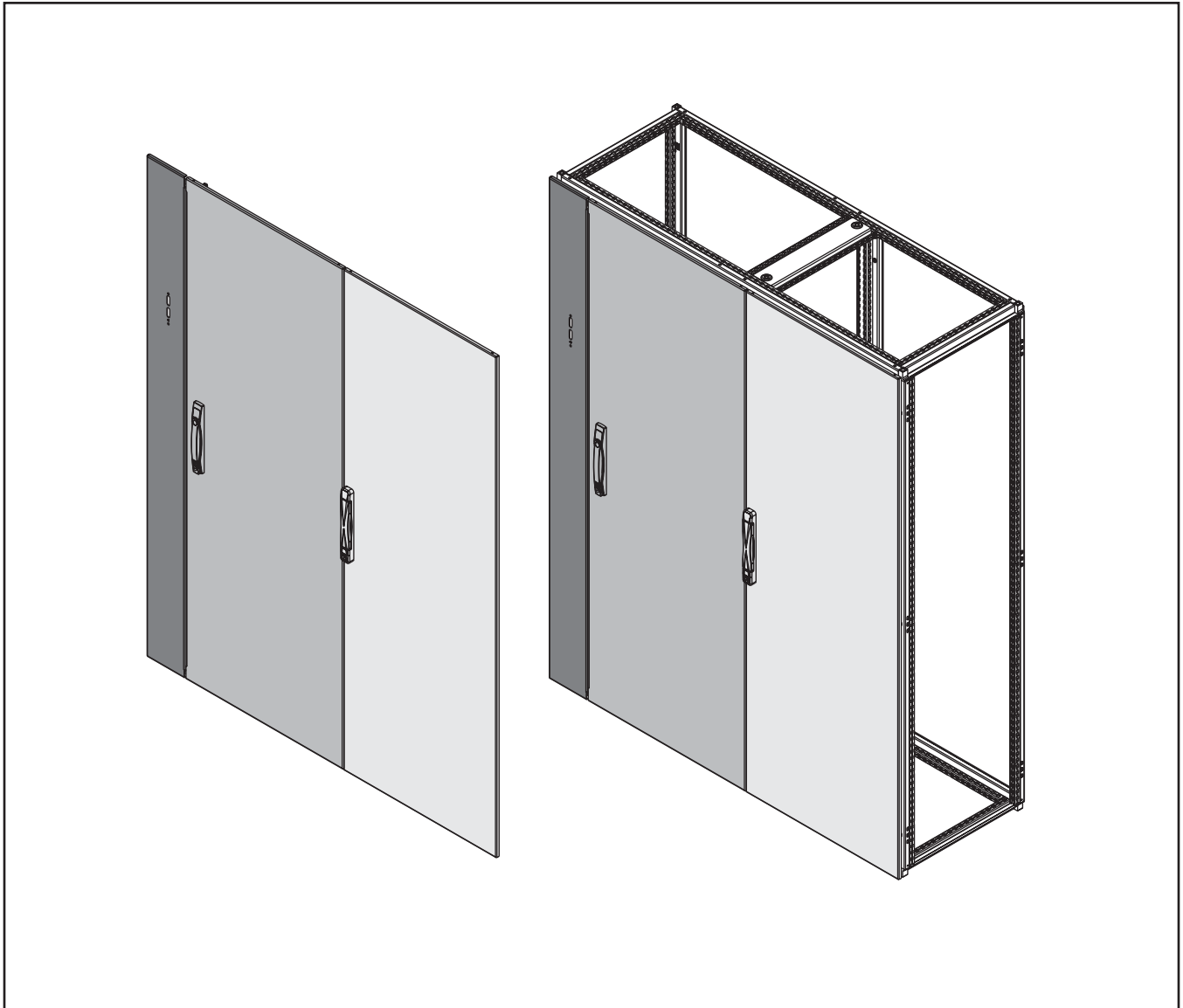

WARNING

The functions, fits, and clearances of the installation described hereon are calculated from information supplied by the manufacturers of the equipment to be installed. Be certain to check the function, fits, and clearances of all equipment both before and after installation to assure that it operates properly and safely and meets all applicable codes, standards and regulations.

In the event the completed installation does not function properly or fails to meet any such codes, standards, or regulations, do not attempt to make alterations or operate the equipment. Report such facts immediately to:

Customer Service Department
Hoffman Customer Service
2100 Hoffman Way
Anoka, MN 55303
763 422 2211
<http://hoffman.nvent.com/contact-us>

INSTALLATION INSTRUCTIONS:

Step 1: Install PROLINE G2 disconnect door and disconnect mullion on a modular frame following disconnect door installation instructions.

Step 2: Install the disconnect/circuit breaker operating handle on the disconnect mullion per the manufacturer's instructions. Remove the pivot bracket shown in Figure 1.

Step 3: Position the pivot bracket (removed in step 2) so that the interlock lever (on the disconnect operating handle) fits between the two adjustable studs. See Figure 1. Secure pivot bracket to disconnect mullion with shoulder collar and hex nut.

Step 4: Close and latch the disconnect mullion to the PROLINE G2 frame. Sliding latches are provided at the top and bottom of the mullion. See Figure 1.

Step 5: Adjust door interlock as follows:

a. Adjust studs on pivot bracket so pivot bracket is horizontal when disconnect operating handle is in the "OFF" (open) position. The interlock lever moves upward when the disconnect handle is operated to the "ON" (closed) position. This motion rotates the pivot bracket so it will engage with the door catch on the disconnect door. Adjust door catch up or down if necessary to provide proper engagement. See Figure 1.

b. Adjust lifting lever (mounted on latch rod). See Figure 1. The lifting lever moves upward as disconnect door is being latched. The lifting lever prevents the pivot bracket from rotating which releases the interlock lever on the disconnect operating handle. This action allows the disconnect operating handle to be operated to the "ON" (closed) position only when disconnect door latching is engaged to the frame.

NOTE: Proper adjustment will allow the operating handle to be placed on the "ON" position when the door is closed and will prevent the door from opening when the operating handle is in the "ON" position. If the door can be opened with the operating handle in the "ON" position, move the door catch up.

(See Figure 1) If the operating handle cannot be pushed up into the "ON" position (with door closed), move the defeater lever on the latch door up slightly. See Figure 1.

Step 6 - Drill mounting holes in subpanel for the specific disconnect switch/circuit breaker being installed per the manufacturer's instructions.

Step 7 - Install subpanel in PROLINE G2 frame (per subpanel instructions) at desired depth (variable in increments of 25mm/.98 inches).

NOTE 1: Variable depth disconnects have a limited depth range. Select a depth for the subpanel that is within the depth range recommended by the disconnect manufacturer.

NOTE 2: Variable depth disconnects operate with a push-pull force from the disconnect operating handle. Larger disconnects have higher operating forces and may require that the subpanel be supported at the center to prevent bowing. Use an additional set of grid straps and a set of panel mounting supports catalog number P2APSB for this purpose.

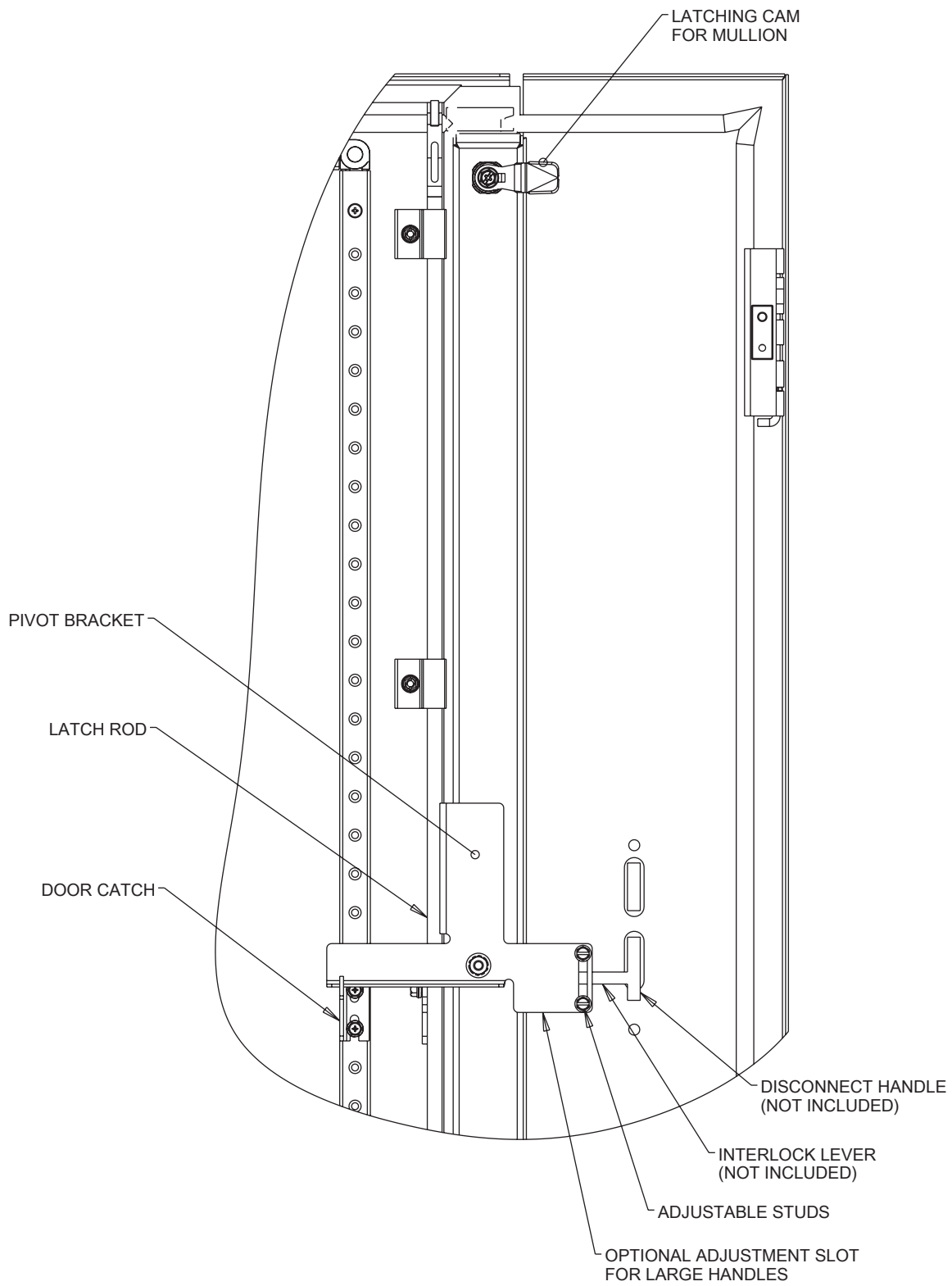



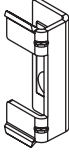



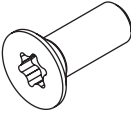
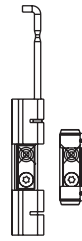
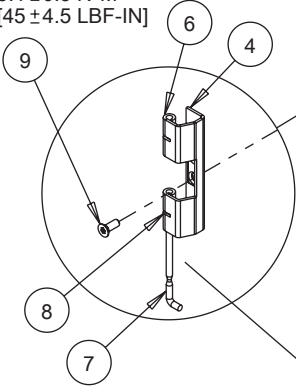

FIGURE 1

<p>1</p>  <p>(1x)</p>	<p>2 DISCONNECT</p>  <p>(1x)</p>	<p>3</p>  <p>(1x)</p>
<p>4</p>  <p>(9x)</p>	<p>5</p>  <p>(3x)</p>	<p>6</p>  <p>(12x)</p>
<p>7</p>  <p>(9x)</p>	<p>8</p>  <p>(9x)</p>	<p>9 M6X16</p>  <p>(12x)</p>



5.1 ± 0.5 N*M
[45 ± 4.5 LBF-IN]



2X

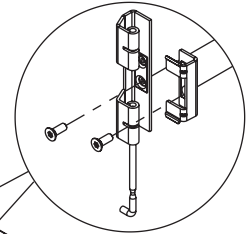

2X

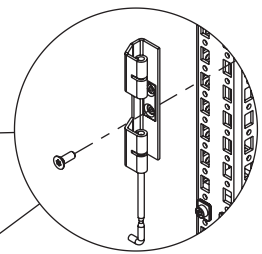

2X

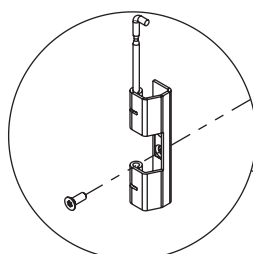

1X

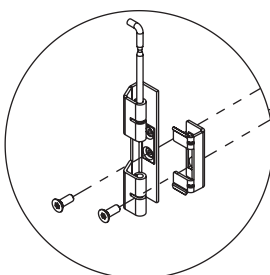

1X

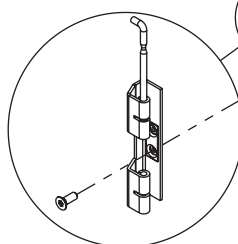

1X

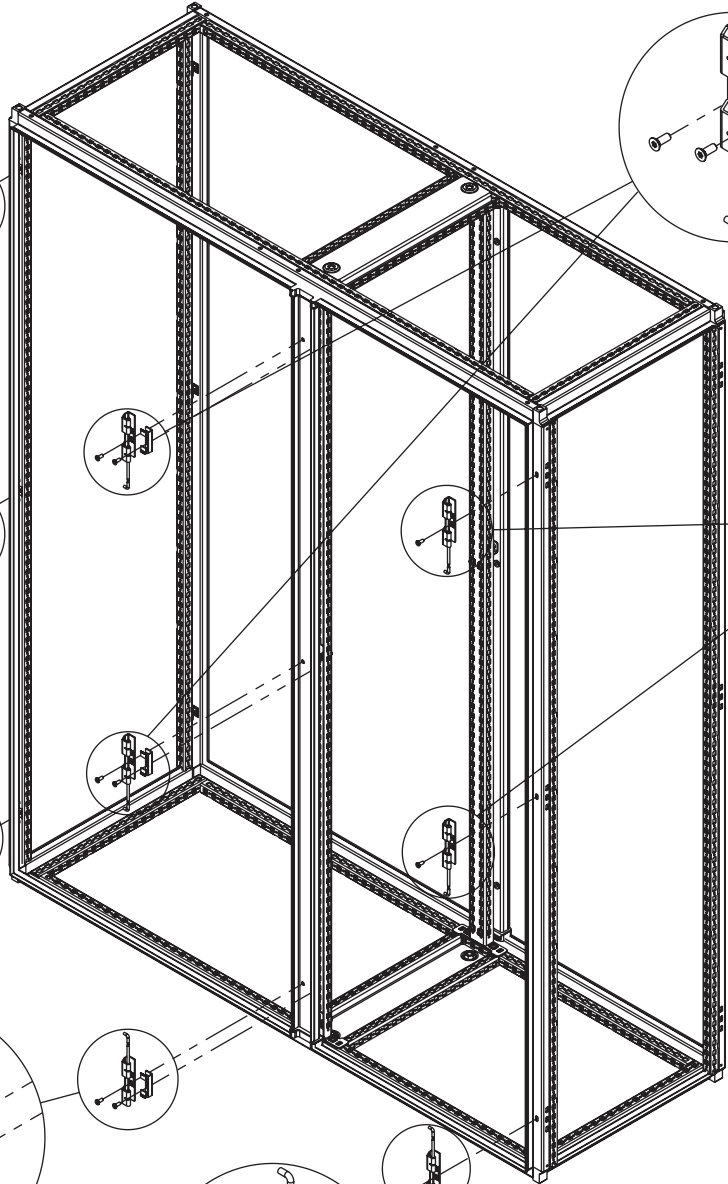

1

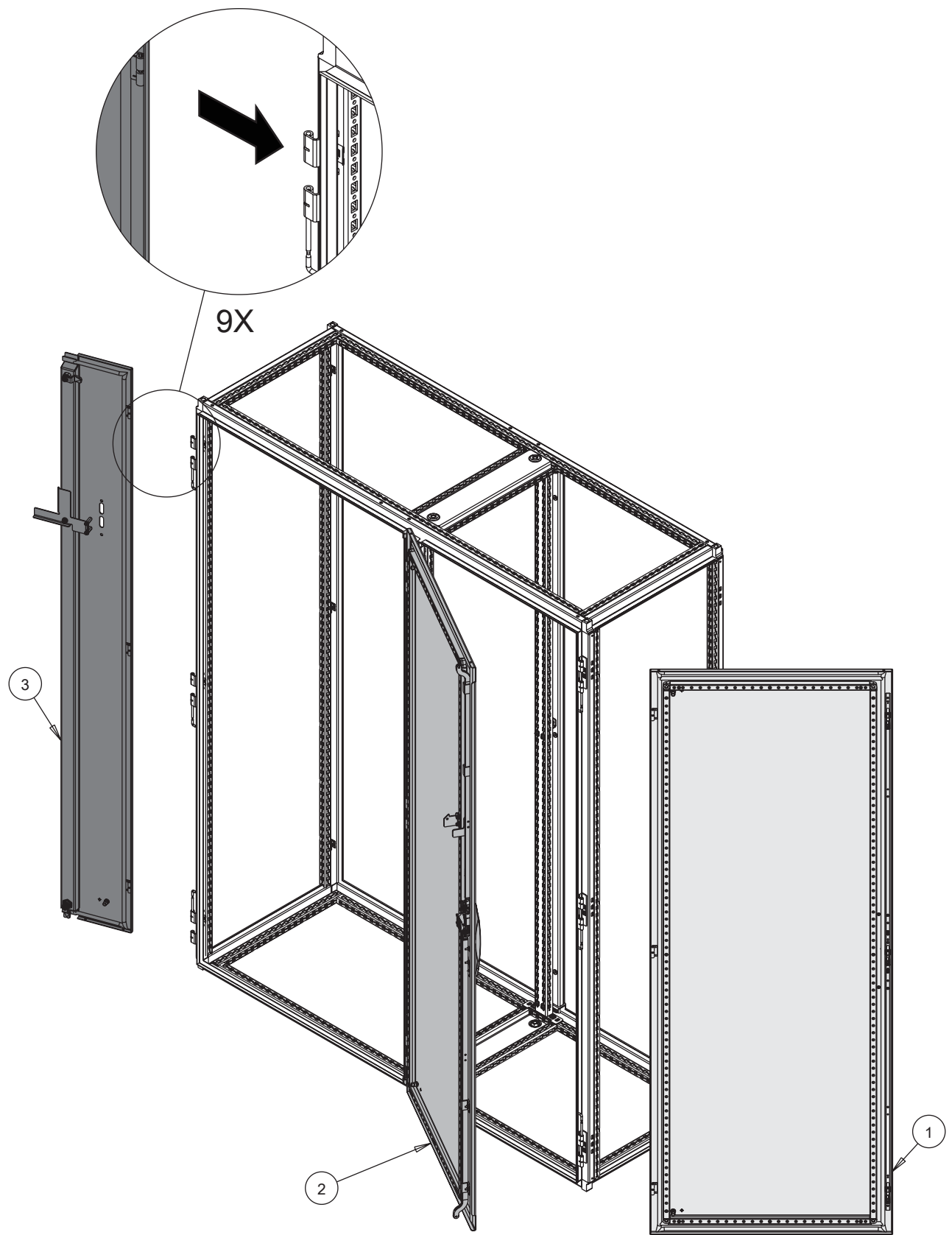

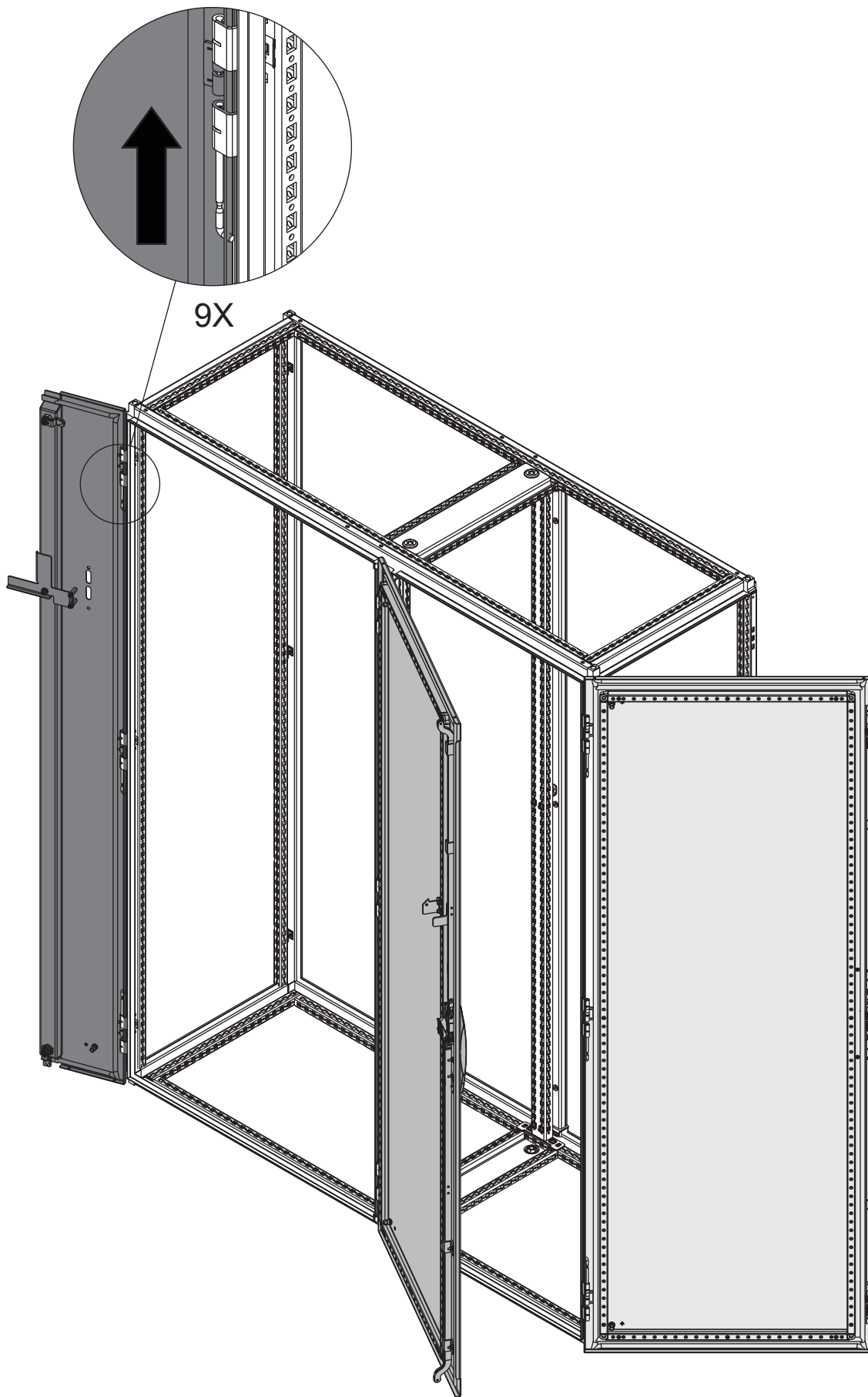

9X

3

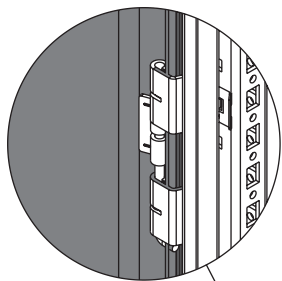

9X

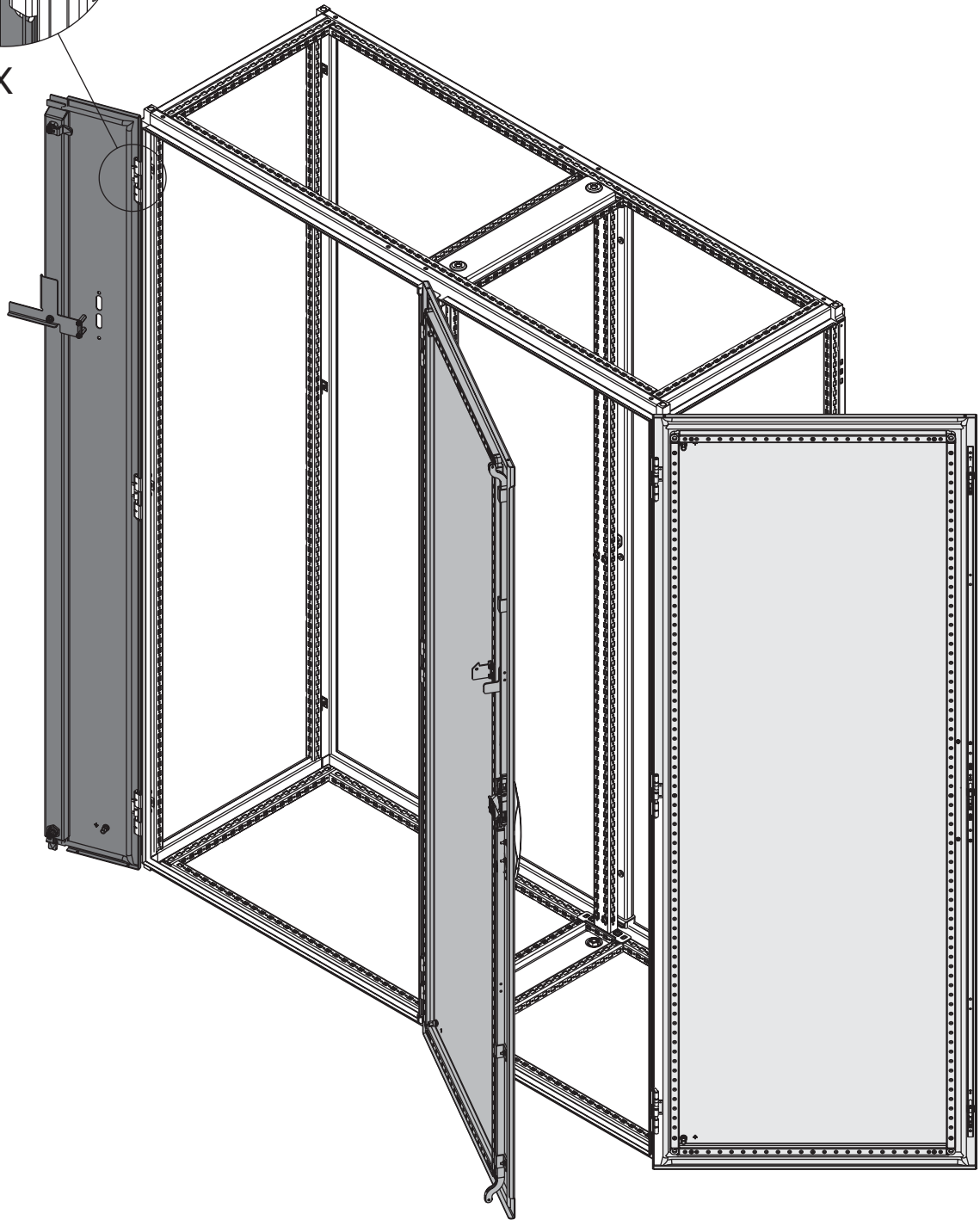

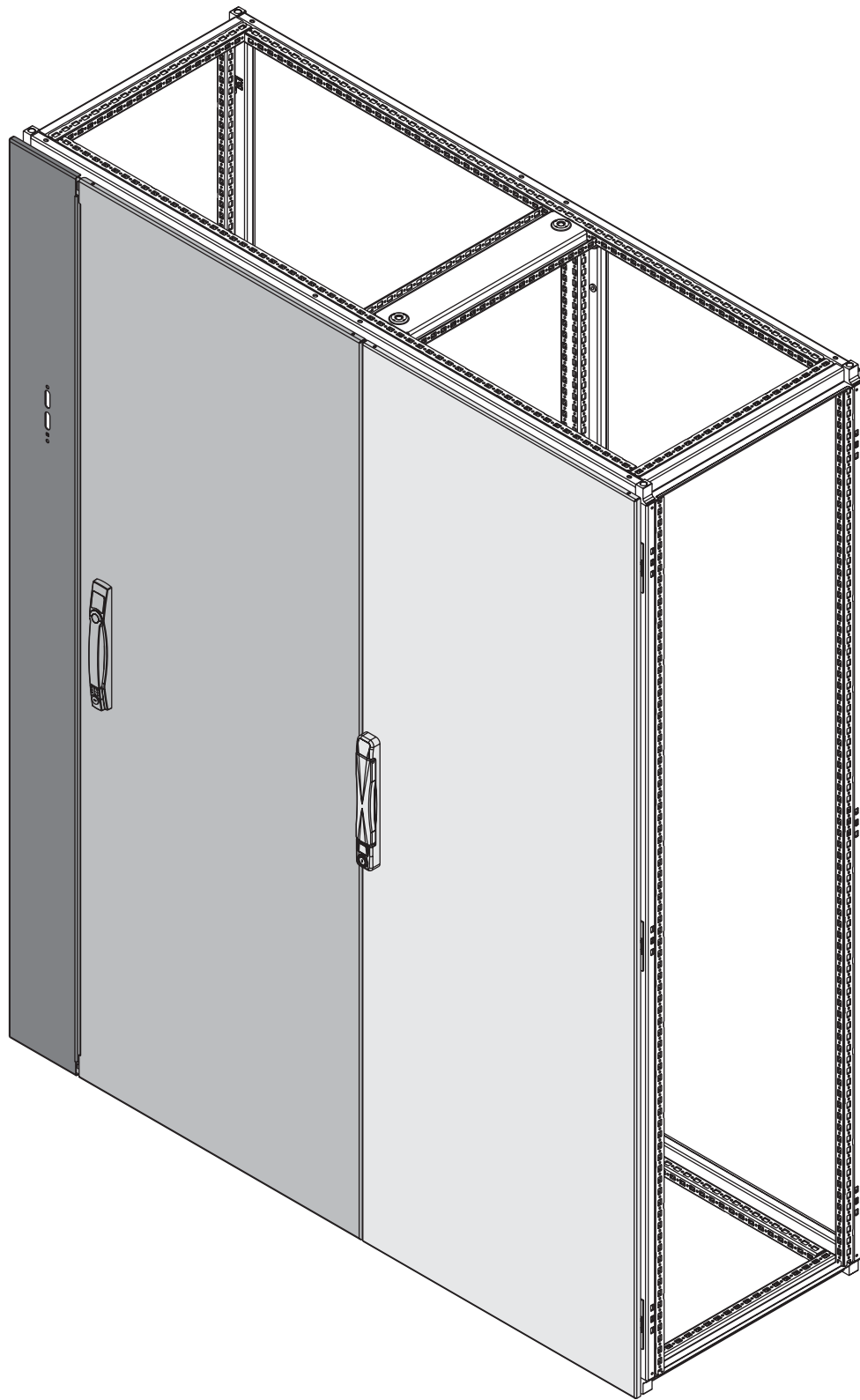

5

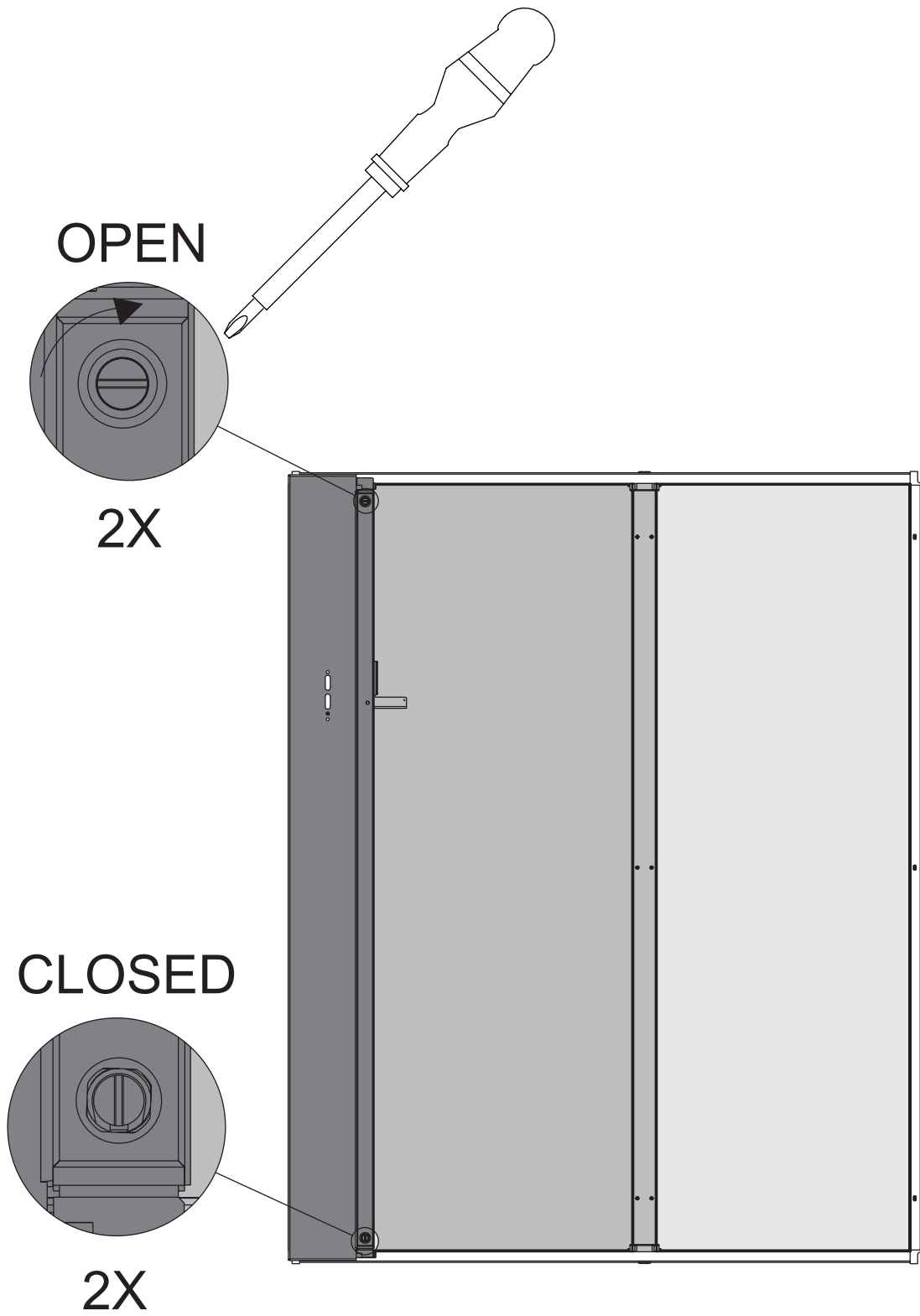

OPEN

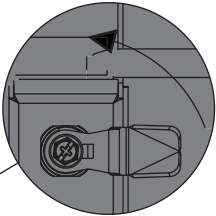

2X

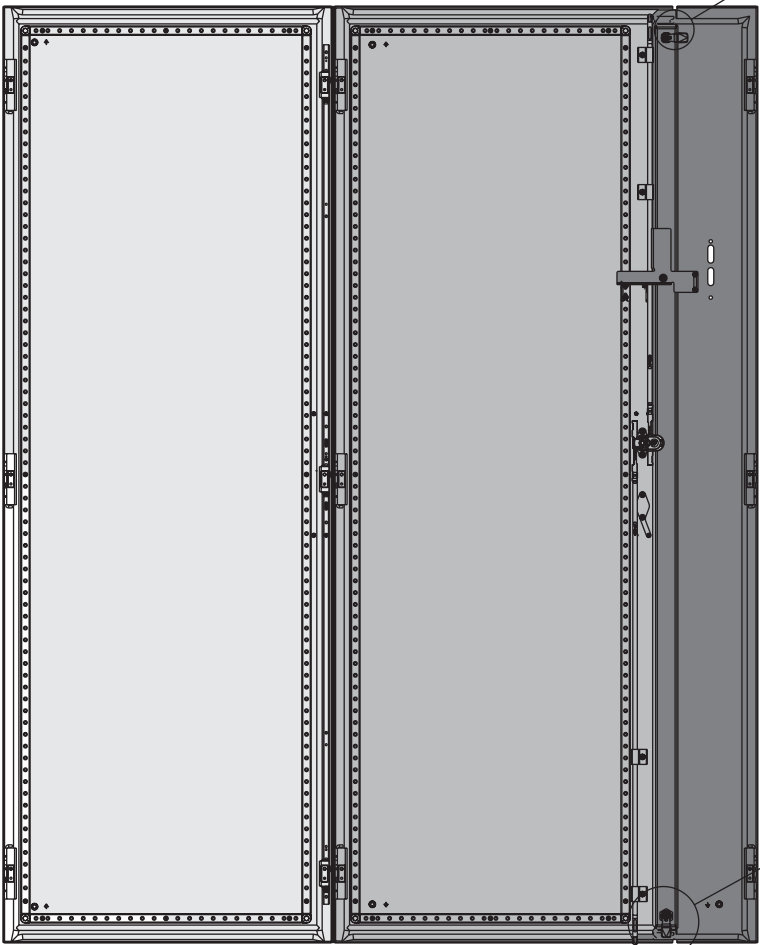

CLOSED

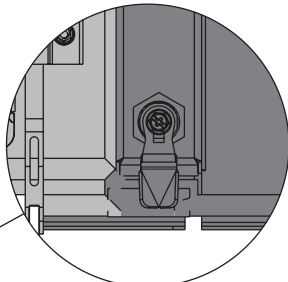

2X



HOFFMAN