



Ratchet-Pro Series Floor Boxes provide access to power, A/V, and communication services to open-space areas.

## Single & Dual-Service Round Floor Boxes

Wiremold® Ratchet-Pro™ Series Floor Boxes provide single- and dual-service capability in a variety of easy-to-install round floor boxes. These designs allow the flexibility for providing power, A/V or communication services to open-space areas in an aesthetic solution.

Applications include malls, shopping centers, department stores, airports, hospitals, and office buildings. Ratchet-Pro™ Series Floor Boxes are cULus Listed for use in both on grade and above grade concrete construction.

## Features & Benefits

- **Ratchet adjusting ring.** Allows for quick and easy installation without gluing, as well as removal of cover to activate at a future date for dual service\*. 10° of flexible adjustment allows cover to conform to the surface of the concrete pour, which significantly reduces labor costs.
- **Parallel conduit hubs.** Allows for conduit feeds to be parallel for both power and communication cables. Reduces labor and material costs by eliminating the need for 90° bends and allows for easier wire pulling for dual-service.
- **Graduated cubic inch markings on interior of the box.** Allows for quick and easy determination of cubic inch capacity – no need for calculations.
- **Complete line of brass, brushed aluminum, and polycarbonate activations.** Provides a wide selection of device and aesthetic options.
- **Corresponding graduated cubic inch markings on divider.** Labor savings provided by easy separation of services. Individual compartment capacities are indicated.
- **Individual conduit reducers & plugs.** Reduction in labor savings by providing a direct reduction to support smaller conduit feeds.
- **Multiple size conduit feeds.** Conduit feed ranging from 3/4" to 2" trade size openings to allow for more flexibility and capacity.
- **2" conduit hub.** By using 2HUB with the RPSFB and RPSFB-OG floor boxes (sold separately) a greater capacity of pre-terminated cables can be brought in shallower concrete pours.
- **Slab-on-grade versions.** Boxes offered in PVC and steel with a special fusion bonded epoxy corrosion resistant paint, enables the boxes to be installed in on-grade applications without the need for additional vapor barriers.
- **Streamlined design of divider.** Labor savings from ease of cutting using a utility knife, no hacksaw or tape measure needed. Also allows for more room to splice wires.
- **"Dead-Front" protection with the RP Series Covers.** Slide covers snap back into place when receptacle is not in use to prevent dirt and debris from entering device.
- **Durable mudcap.** High impact mudcap protects box from damage when heavy equipment such as scissor lift trucks come in contact with the box during installation.
- **TopGuard protection.** An integral design which keeps out water, dirt, and debris from the power or communication compartment. Whenever you see the TopGuard protection icon applied to any Wiremold product, you will know that the product meets and exceeds the new UL scrub water exclusion requirement.
- **UL Listed to U.S. and Canadian safety standards for tile, terrazzo, and the new UL requirements under UL514A and UL514C for scrub water exclusion test for carpet and wood floors.**

## Vertical Markets

- Commercial
- Healthcare
- Hospitality
- Education
- Retail
- Financial

## Compliance



cULus Listed Nonmetallic Outlet Boxes. File E110748 Guide QCMZ.  
cULus Listed Metallic Outlet Boxes. File E2961 Guide QCIT.



Protection from water, dirt, and debris.

**Ratchet-Pro Series Floor Box Components**

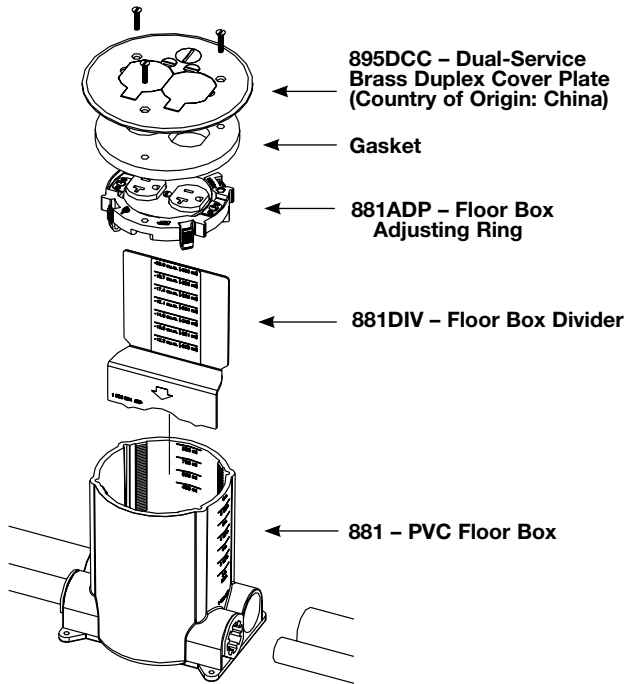

Ratchet-Pro 881 Series Floor Box Volume Capacities					
To calculate the total box volume, use displacement of the largest uncut section remaining.					
BOX HEIGHT		Single Service 895 & 896 Activations		Dual Service 895DCC Activations	
Inches	[mm]	WIRING VOLUME		WIRING VOLUME (with Divider)	
		Cu. Inches	[mm]	Cu. Inches	[mm]
6	[152.0]	65.0	[1065.0]	15.0	[738.0]
5 1/2	[140.0]	58.0	[950.0]	39.3	[644.0]
5	[127.0]	51.0	[835.0]	33.6	[551.0]
4 1/2	[114.0]	44.0	[720.0]	27.9	[457.0]
4	[102.0]	37.0	[605.0]	22.2	[364.0]
3 1/2	[89.0]	30.0	[490.0]	16.5	[270.0]
3	[76.0]	23.0	[377.0]	10.8	[177.0]

**NOTE:** To calculate total box volume, use the displacement of the largest uncut section remaining. Do not use in concrete pours less than 4 1/2" [114mm] deep. Installation must comply with NEC and local code conductor volume requirements. Not for use when concrete is the finished floor. Use only for tile, carpet, or wood covered floors.



Ratchet-Pro Series Floor Box shown with available accessories and covers.

### Ratchet-Pro Series Floor Box Wire Fill Capacity Charts

Wire Fill Calculations for RPSFB & RPSFB-OG Floor Boxes							
Minimum Box Height (Measured inside from top of cut box – Disregard excess height)		Volume – Cat. No. RPSFB (Each Gang)		RP7CTC & RP4FFCTC (Available Volume for Conductor Calculations)		RPAV3CTC & RP4CTC (Available Volume for Conductor Calculations)	
3 1/2"	89mm	55 cu.in.	901 ml.	Not recommended for pours less than 4" [102mm]			
4"	102mm	60 cu.in.	983 ml.	56 cu.in.	918 ml.	45 cu.in.	738 ml.
4 1/2"	114mm	65 cu.in.	1065 ml.	61 cu.in.	1000 ml.	50 cu.in.	820 ml.
5"	127mm	70 cu.in.	1147 ml.	66 cu.in.	1082 ml.	55 cu.in.	901 ml.
5 1/2"	140mm	75 cu.in.	1229 ml.	71 cu.in.	1164 ml.	60 cu.in.	983 ml.
6"	152mm	80 cu.in.	1311 ml.	76 cu.in.	1246 ml.	65 cu.in.	1065 ml.

Wire Fill Calculations for RPNFB Floor Boxes							
Minimum Box Height (Measured inside from top of cut box – Disregard excess height)		Volume – Cat. No. RPNFB (Each Gang)		RP7CTC & RP4FFCTC (Available Volume for Conductor Calculations)		RPAV3CTC & RP4CTC (Available Volume for Conductor Calculations)	
3 1/2"	89mm	35 cu.in.	574 ml.	Not recommended for pours less than 4" [102mm]			
4"	102mm	40 cu.in.	656 ml.	36 cu.in.	590 ml.	25 cu.in.	410 ml.
4 1/2"	114mm	45 cu.in.	738 ml.	41 cu.in.	672 ml.	30 cu.in.	492 ml.
5"	127mm	50 cu.in.	820 ml.	46 cu.in.	754 ml.	35 cu.in.	574 ml.
5 1/2"	140mm	55 cu.in.	901 ml.	51 cu.in.	836 ml.	40 cu.in.	656 ml.
6"	152mm	60 cu.in.	983 ml.	56 cu.in.	918 ml.	45 cu.in.	738 ml.

For single service activations – RPAMD4CTC, RPAMD8CTC and RP9AM2CTC, combine both gangs to determine available wire fill.

881 with 895 Cover



RPSFB-OG with RP4CTC Cover

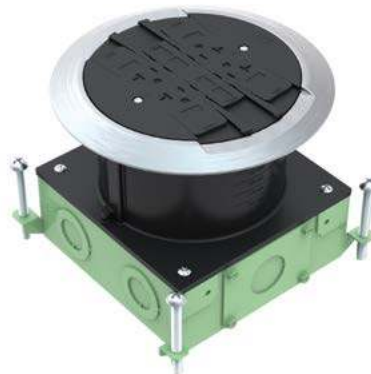

## Ratchet-Pro Series Floor Box Ordering Information

881

**Round Nonmetallic Concrete Floor Box** – Round single service nonmetallic concrete floor box. Floor box has four (4) parallel conduit hubs, internal and external graduated markings indicating wiring volume and concrete pour depth respectively.

**Box Includes:**

- (1) Durable/reusable protective cap.
- (1) Adapter ring (881ADP).
- (1) Reducing ring to allow hub to be reduced down to 3/4" and 1/2" trade size openings or blanks to close off any unused openings.

**Country of Origin: USA**

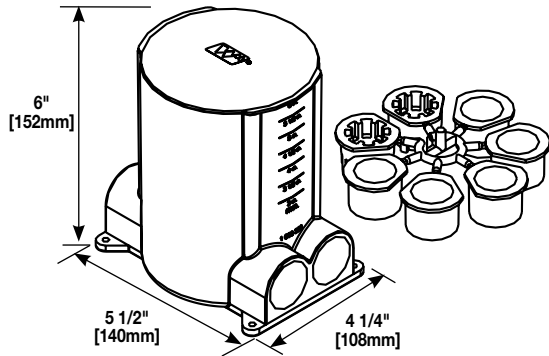

881DIV

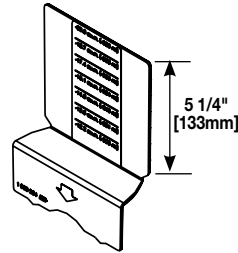

**PVC Floor Box Divider Plate** – Used to isolate power and communication compartments. Graduated cubic inch markings are marked clearly on the divider and correspond directly to the cubic inch markings on the interior of the box. Cuts easily with a utility knife. Supplied with a receptacle plate that completes separation of power and communication services. One divider required for **dual-service** activation.

**Country of Origin: USA**

895DCC

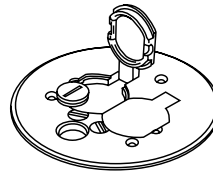

**Dual-Service Brass Duplex Cover Plate** – With flip lids. Supplied with 1/2" [12.7mm] screw plug for accessing communication cables. 5 1/2" [140mm] diameter for **carpet applications only**. Used in conjunction with the 881DIV to complete dual-service activation.

**Country of Origin: China**

881ADP

**PVC Floor Box Ratchet Adjusting Ring** – Used to attach wiring devices and cover plates to PVC Box. Locks into place without using glue or mechanical fasteners. Compensates for up to 10° of tilt if box is not level. Ground wire is factory attached to the adjusting ring.

**Country of Origin: USA**

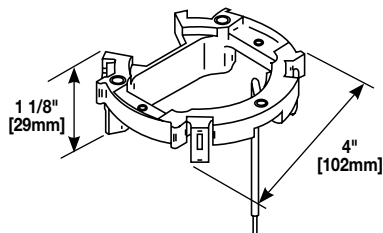

**NOTE:** One ring required per box, single- or dual-service.



Ratchet-Pro Series Floor Box can be used in both on grade and above grade concrete construction.

**North American Made Ratchet-Pro Series Floor Box Cover Plates Ordering Information**

**895P-BLK  
895P-BRN  
895P-BRZ  
895P-AL**

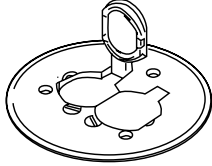

**Polycarbonate Duplex Cover Plate –**  
With flip lids, 5 1/2" [140mm] diameter for carpet. Available in black 895P-BLK, brown 895P-BRN, bronze 895P-BRZ, and aluminum 895P-AL.

**Country of Origin: USA**

**896PCK-BLK  
896PCK-BRN  
896PCK-BRZ  
896PCK-AL**

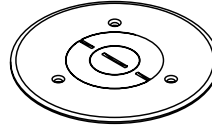

**Polycarbonate Communication or Power Cover Plate – 5 1/2" [140mm] diameter.** Available in black 896PCK-BLK, brown 896PCK-BRN, bronze 896PCK-BRZ and aluminum 896PCK-AL.

**Country of Origin: USA**

**Ratchet-Pro Series Floor Box Cover Plate Ordering Information**

**895**

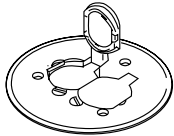

**Brass Duplex Cover Plate – With flip lids, 5 1/2" [140mm] diameter for carpet.**

**Country of Origin: China**

**895SPCAL**

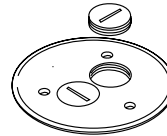

**Brushed Aluminum Cover Plate – With two screw plug openings, 5 1/2" [140mm] diameter for carpet.** Screw plug openings are 1 1/2" [38mm] – 16 tapped openings.

**Country of Origin: China**

**895TCAL**

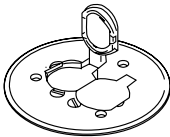

**Brushed Aluminum Duplex Cover Plate – With flip lids, 5 1/2" [140mm] diameter for carpet.**

**Country of Origin: China**

**895GFI**

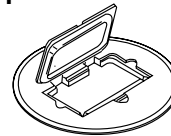

**Brass GFI Receptacle Cover Plate – 5 1/2" [140mm] diameter for carpet.**

**Country of Origin: China**

**895TCAL-BK  
895TCAL-BS  
895TCAL-GY  
895TCAL-NK  
895TCAL-BZ**

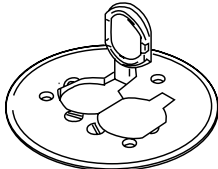

**Aluminum Duplex Power Plate – With flip lids, 5 1/2" [140mm] diameter for carpet.** Available in black 895AL-BK, brass 895AL-BS, gray 895AL-GY, nickel 895AL-NK and bronze 895AL-BZ.

**Country of Origin: China**

**895GFICAL**

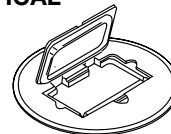

**Brushed Aluminum GFI Receptacle Cover Plate – 5 1/2" [140mm] diameter for carpet.**

**Country of Origin: China**

**895SP**

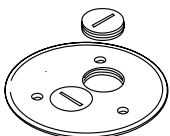

**Brass Cover Plate – With two screw plug openings, 5 1/2" [140mm] diameter for carpet.** Screw plug openings are 1 1/2" [38mm] – 16 tapped openings.

**Country of Origin: China**

**895TGFI**

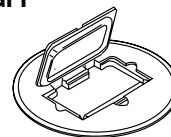

**Brass GFI Receptacle Cover Plate – 4 1/4" [108mm] diameter for tile.**

**Country of Origin: China**

**895TGFIAL**

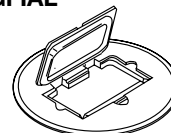



**Brushed Aluminum GFI Receptacle Cover Plate – 4 1/4" [108mm] diameter for tile.**

**Country of Origin: China**

**NOTE:** 1. All cover plates are furnished with gasket and three screws.  
2. The 895P Polycarbonate Series Cover Plates must be field modified for dual-service.

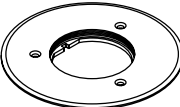
**Ratchet-Pro Series Floor Box Cover Plate Ordering Information**

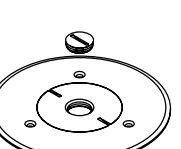
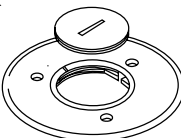
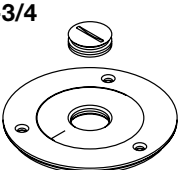
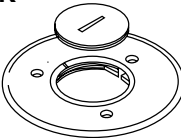
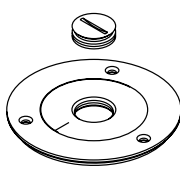
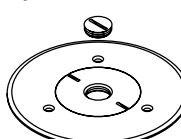
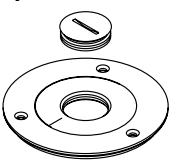
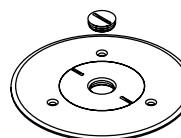
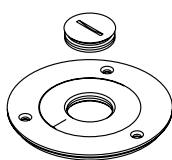
<p><b>896</b></p> 	<p><b>Brass Communication or Power Cover Plate</b> – With 2 5/8" [67mm] threaded opening, 5 1/2" [140mm] diameter for carpet.</p> <p><b>Country of Origin: China</b></p>	<p><b>896TCK-1/2</b></p> 	<p><b>Brass Cover Plate</b> – With 1/2" [12.7mm] threaded opening, 4 1/4" [108mm] diameter for tile.</p> <p><b>Country of Origin: China</b></p>
<p><b>896T</b></p> 	<p><b>Brass Communication or Power Cover Plate</b> – With 2 5/8" [67mm] threaded opening, 4 1/4" [108mm] diameter for tile. Abandon plug not included.</p> <p><b>Country of Origin: China</b></p>	<p><b>896TCKAL-1/2</b></p> 	<p><b>Brushed Aluminum Cover Plate</b> – With 1/2" [12.7mm] threaded opening, 4 1/4" [108mm] diameter for tile.</p> <p><b>Country of Origin: China</b></p>
<p><b>896CK</b></p> 	<p><b>Brass Communication or Power Cover Plate</b> – With 2 1/4" [57mm] threaded opening, 5 1/2" [140mm] diameter for carpet.</p> <p><b>Country of Origin: China</b></p>	<p><b>896CK-3/4</b></p> 	<p><b>Brass Cover Plate</b> – With 3/4" [19.1mm] threaded opening, 5 1/2" [140mm] diameter for carpet.</p> <p><b>Country of Origin: China</b></p>
<p><b>896TCK</b></p> 	<p><b>Brass Communication or Power Cover Plate</b> – With 2 1/4" [57mm] threaded opening, 4 1/4" [108mm] diameter for tile.</p> <p><b>Country of Origin: China</b></p>	<p><b>896TCK-3/4</b></p> 	<p><b>Brass Cover Plate</b> – With 3/4" [19.1mm] threaded opening, 4 1/4" [108mm] diameter for tile.</p> <p><b>Country of Origin: China</b></p>
<p><b>896CK-1/2</b></p> 	<p><b>Brass Cover Plate</b> – With 1/2" [12.7mm] threaded opening, 5 1/2" [140mm] diameter for carpet.</p> <p><b>Country of Origin: China</b></p>	<p><b>896CK-1</b></p> 	<p><b>Brass Cover Plate</b> – With 1" [25mm] threaded opening, 5 1/2" [140mm] diameter for carpet.</p> <p><b>Country of Origin: China</b></p>
<p><b>896CKAL-1/2</b></p> 	<p><b>Brushed Aluminum Cover Plate</b> – With 1/2" [12.7mm] threaded opening, 5 1/2" [140mm] diameter for carpet.</p> <p><b>Country of Origin: China</b></p>	<p><b>896TCK-1</b></p> 	<p><b>Brass Cover Plate</b> – With 1" [25mm] threaded opening, 4 1/4" [108mm] diameter for tile.</p> <p><b>Country of Origin: China</b></p>

**NOTE:** 1. All cover plates are furnished with gasket and three screws.  
2. The 895P Polycarbonate Series Cover Plates must be field modified for dual-service.

### Ratchet-Pro RPSFB & RPSFB-OG Series Floor Box Ordering Information

**RPSFB**

**Rectangular Dual Service Metal Concrete Floor Box –**

Rectangular dual service metal concrete floor box with a non-metallic top that allows for concrete pours between 4" thick to 6" thick. Graduated markings on the inside and outside of the box indicating volume capacity, as well as the depth of concrete pour. Box accepts 2HUB to allow 2" conduit feeds (sold separately) while maintaining a 4" deep concrete pour.

**Box includes:**

- (1) Reusable concrete cap
- (2) Removable knockout plates to allow the 2HUB to be attached

**RPSFB-OG**

**On-Grade Rectangular Dual Service Metal Concrete Floor Box –**

Rectangular dual service metal concrete floor box with a non-metallic top that allows for concrete pours between 4" thick to 6" thick. Graduated markings on the inside and outside of the box indicating volume capacity, as well as the depth of concrete pour. Box accepts 2HUB to allow 2" conduit feeds (sold separately) while maintaining a 4" deep concrete pour.

**Box includes:**

- (1) Reusable concrete cap
- (2) Removable knockout plates to allow the 2HUB to be attached.

Country of Origin: Mexico

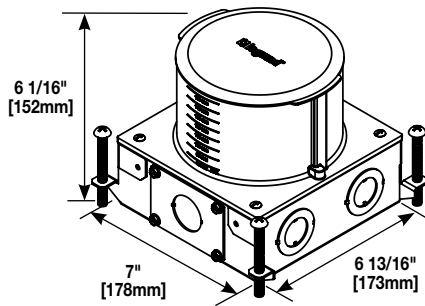

Country of Origin: Mexico

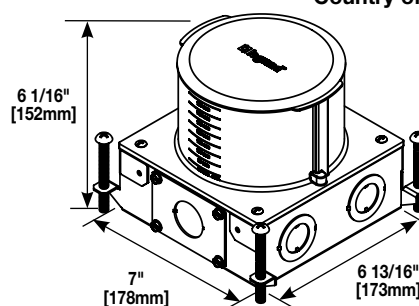

### RPSFB & RPSFB-OG Dimensions & Knockout Locations

**RPSFB**

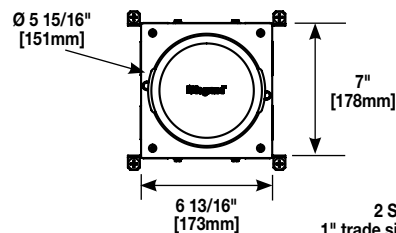

2 SIDES:  
1" trade size KO inside a removable plate

**RPSFB-OG**

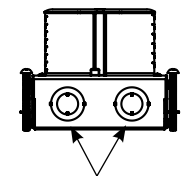
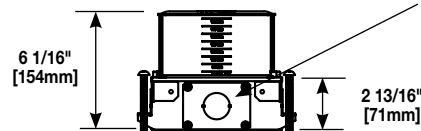

2 SIDES:  
3/4" & 1 1/4" trade size concentric KOs

BOTTOM:  
1 1/2" trade size KOs

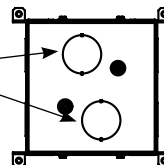

**Ratchet-Pro RPNFB Series Floor Box Ordering Information**

**RPNFB**

**Round Dual Service Nonmetallic Concrete Floor Box –**

Round dual service nonmetallic concrete floor box. Floor box has two 1 1/4" trade size conduit hubs for power and two 2" trade size conduit hubs for communications and audio/video services.

**Box Includes:**

- (1) Reusable concrete cap
- (1) Reducing ring for the 2" hubs that can be reduced down to 1 1/2 Trade size, and 1 1/4" trade size openings.
- (1) Reducing ring for the 1 1/4" hubs that allow to be reduced to 1" trade size opening or 3/4" trade size opening.

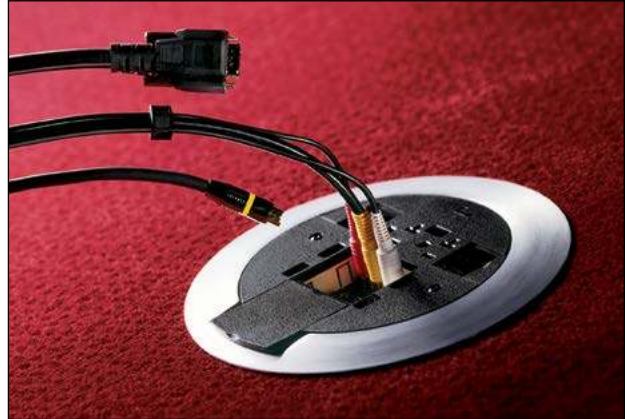

Ratchet-Pro Series Floor Box installations provide easy access to power, communication and A/V services in open spaces.

Country of Origin: USA

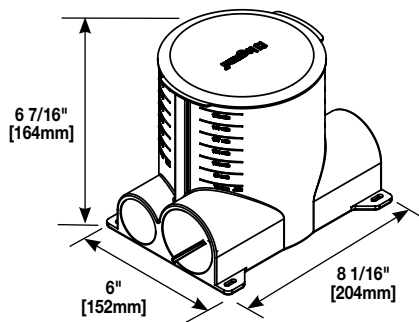

RPNFB



**RPNFB Dimensions & Knockout Locations**

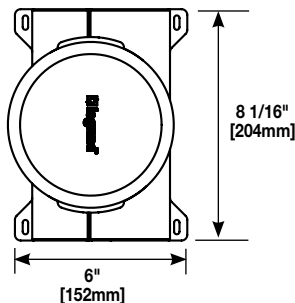

2 SIDES:  
2" trade size  
Conduit Hub

2 SIDES:  
1 1/4" trade size  
Conduit Hub

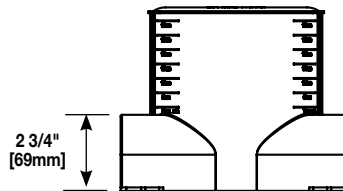
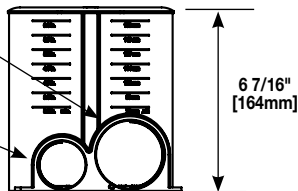

**Ratchet-Pro RPNFB, RPSFB & RPSFB-OG Series Floor Box Kits Ordering Information**

Catalog No./Item	Flange Color	Slide Holder Color	Description/Specifications
RPAV3CTCGY RPAV3CTCBK RPAV3CTCAL RPAV3CTCBS RPAV3CTCAA RPAV3CTCAB	Gray Black Aluminum Brass All Aluminum All Brass	Gray Black Black Black Aluminum Brass	<b>Multiple Service Floor Box Cover Kit</b> – Kit comes complete with (1) prewired 20A duplex receptacle, (receptacle can be wired as a standard receptacle or isolated ground), flange and slide holder, adapter ring to secure into the boxes, divider (RP-DIV). Wiremold CM series open system adapters (unloaded), Ortronics® Series II, TracJack adapters and adapter to accept AVIP or Extron® Electronics MAAP devices. Modular jacks and A/V connectors sold separately. <b>Minimum concrete pour height: 4" [102mm].</b>
			<b>Country of Origin: Mexico</b>
RP4CTCGY RP4CTCBK RP4CTCAL RP4CTCBS RP4CTCAA RP4CTCAB	Gray Black Aluminum Brass All Aluminum All Brass	Gray Black Black Black Aluminum Brass	<b>Multiple Service Floor Box Cover Kit</b> – For RPSFB, RFSFB-OG, and RPNFB floor boxes. Kit comes complete with (2) prewired 20A duplex receptacles, (receptacles can be wired as standard receptacle, or isolated ground), flange and slide holder, adapter ring to secure into the boxes, divider (RP-DIV), Wiremold CM Series open system adapters (unloaded), Ortronics® Series II and TracJack adapters. Modular jacks sold separately. <b>Minimum concrete pour height: 4" [102mm].</b>
			<b>Country of Origin: Mexico</b>
RP7CTCGY RP7CTCBK RP7CTCAL RP7CTCBS RP7CTCAA RP7CTCAB	Gray Black Aluminum Brass All Aluminum All Brass	Gray Black Black Black Aluminum Brass	<b>Multiple Service Floor Box Cover Kit</b> – Kit comes complete with (1) prewired 20A duplex receptacle, (receptacle can be wired as a standard receptacle, or isolated ground), flange and slide holder, adapter ring to secure into the boxes, divider (RP-DIV), Wiremold CM Series open system adapters (unloaded), Ortronics® Series II, and TracJack adapters. Modular jacks and A/V connectors sold separately. <b>Minimum concrete pour height: 4" [102mm].</b>
			<b>Country of Origin: Mexico</b>
RPAMD4CTCGY RPAMD4CTCBK RPAMD4CTCAL RPAMD4CTCBS RPAMD4CTCAA RPAMD4CTCAB	Gray Black Aluminum Brass All Aluminum All Brass	Gray Black Black Black Aluminum Brass	<b>Single Service Floor Box Cover Kit</b> – Kit comes complete with adapter ring to secure into the boxes, Wiremold CM Series open system adapters (unloaded), Ortronics® Series II, and TracJack adapters. Modular jacks and A/V connectors sold separately. <b>Minimum concrete pour height: 3 1/2" [89mm].</b>
			<b>Country of Origin: Mexico</b>

NOTE: See Volume Fill Charts on page 3.

CAUTION: For use on bare concrete floors, or floors with tile, carpet, wood or terrazzo coverings.

**Ratchet-Pro RPNFB, RPSFB & RPSFB-OG Series Floor Box Kits Ordering Information**

Catalog No./Item	Flange Color	Slide Holder Color	Description/Specifications
RPAMD8CTCGY	Gray	Gray	<b>Single Service Floor Box Cover Kit</b> – Kit comes complete with adapter ring to secure into the boxes, Wiremold CM Series open system adapters (unloaded), Ortronics® Series II, and TracJack adapters. Modular jacks and A/V connectors sold separately. <b>Minimum concrete pour height: 3 1/2" [89mm].</b>
RPAMD8CTCBK	Black	Black	
RPAMD8CTCAL	Aluminum	Black	
RPAMD8CTCBS	Brass	Black	
RPAMD8CTCAA	All Aluminum	Aluminum	
RPAMD8CTCAB	All Brass	Brass	

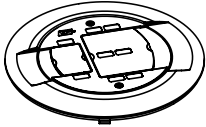

Country of Origin: Mexico

RP4FFCTC15GY	Gray	<b>Multiple Service Furniture Feed Floor Box Cover Kit</b> – Kit comes complete with adapter ring to secure into the boxes, (1) 3/4" trade size screw plug and conduit fitting for power, 1-1/2" trade size screw plug and conduit fitting for low voltage (communications or A/V) services. <b>Minimum concrete pour height: 3 1/2" [89mm].</b>
RP4FFCTC15BK	Black	
RP4FFCTC15AL	Aluminum	
RP4FFCTC15BS	Brass	
RP4FFCTC15AA	All Aluminum	
RP4FFCTC15AB	Bronze	

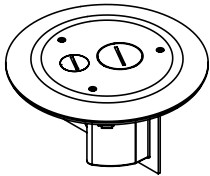

Country of Origin: Mexico

RP9AM2CTCGY	Gray	<b>Single Service Furniture Feed Floor Box Cover Kit</b> – Kit comes complete with adapter ring to secure into the boxes, (1) 1-1/4 / 2" concentric screw plug closure plug. Conduit fittings sold separately by others. <b>Minimum concrete pour height: 3 1/2" [89mm].</b>
RP9AM2CTCBK	Black	
RP9AM2CTCAL	Aluminum	
RP9AM2CTCBS	Brass	

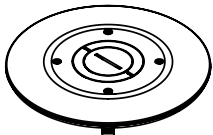

Country of Origin: Mexico

**2HUB**

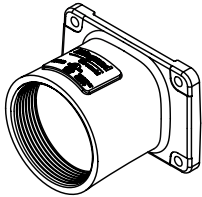

**2" Conduit Transition Hub** – Trade size 2" die cast zinc conduit fitting allows for 2" conduit to transition into a shallow box design. Includes: die cast fitting gasket. Accepts standard 2" threaded conduit or trade size EMT and PVC conduit fittings.

Country of Origin: USA

NOTE: For use with RPSFB & RPSFB-OG Series Floor Boxes.

**RP-DIV**

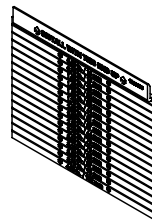

**Divider** – Used to isolate power and low voltage (communications and audio/video) compartments. Graduated markings indicating location to cut divider to, in order to match concrete pour.

Country of Origin: USA

NOTE: See Volume Fill Charts on page 3.

## Ratchet-Pro RPNFB, RPSFB & RPSFB-0G Series Floor Box Kits Ordering Information

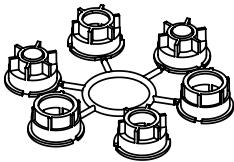
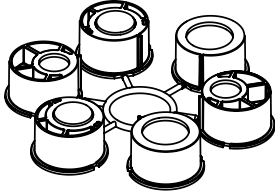
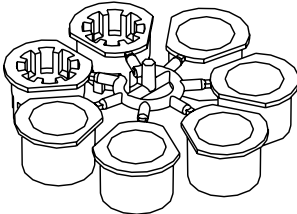
Catalog No./Item	Description/Specifications
<b>125CRR</b> 	<b>Conduit Reducing Ring –</b> Conduit reducing ring allows for 1 1/4" conduit hub (for RPNFB only) to allow for smaller conduit feeds where needed. Ring includes: (2) blanking plug, (2) 3/4" trade size plugs, and (2) 1" trade size plugs.  <b>Country of Origin: USA</b>
<b>2CRR</b> 	<b>Conduit Reducing Ring –</b> Conduit reducing ring allows for 2" conduit hub (for RPNFB only) to allow for smaller conduit feeds where needed. Ring includes: (2) 1-1/2" trade size plugs, (2) 1-1/4" trade size plugs, and (2) blank plugs.  <b>Country of Origin: USA</b>
<b>1CRR</b> 	<b>Conduit Reducing Ring –</b> Conduit reducing ring allows for 1" conduit hub to accept smaller conduit feeds where needed. Ring includes: two (2) blanking plugs, (2) 3/4" trade size plugs, and (2) 1/2" trade size plugs.  <b>Country of Origin: USA</b>

### 1CRR Top and Bottom Views



**NOTE:** All brand and product names referenced in this document are registered trademarks or trademarks of their respective holders.

---



**Legrand, North America**  
60 Woodlawn Street  
West Hartford, CT 06110  
1.877.BY.LEGRAND (295.3472)  
[www.legrand.us](http://www.legrand.us)

**Canada**  
905.738.9195  
[www.legrand.ca](http://www.legrand.ca)

FOLLOW US

